



# INTENSITY<sup>®</sup>

Refresh your life



## AIR COOLED SCREW CHILLER

100 TO 400 TONS.

## TECHNICAL MANUAL



[intensity.mx](https://intensity.mx)



MAN-T-ACSCH-0216

---

# Contents

<b>I. Safety precautions</b> .....	<b>2</b>
1. Installation safety considerations .....	2
2. Maintenance safety considerations .....	2
3. Repair safety considerations .....	3
<b>II. Product</b> .....	<b>5</b>
1. General Information .....	5
2. Feature .....	7
3. Specification .....	9
4. Outline dimension .....	11
5. Refrigeration system.....	19
6. Key parts list.....	21
7. Application .....	22
8. Capacity table .....	25
9. Accessories .....	29
<b>III. Controls</b> .....	<b>30</b>
1. Control flow chart.....	30
2. Energy adjustment .....	31
3. Start/stop process .....	31
4. Sensors.....	34
5. Parts control.....	34
6. HMI operation.....	41
7. Control screen menu structure .....	56
8. Safety protection .....	57
<b>IV. Electrical control</b> .....	<b>58</b>
1. Electrical data .....	58
2. Electrical components introduction .....	58
3. Electrical components parameter setting .....	60
4. Field wiring.....	63
<b>V. Installation</b> .....	<b>67</b>
1. Unit installation.....	67
2. Water pipeline system installation .....	70
3. Wiring installation.....	74
<b>VI. Commissioning</b> .....	<b>76</b>
1. Pre start-up.....	76
2. Start-up .....	79
<b>VII. Maintenance</b> .....	<b>82</b>
1. Daily maintenance .....	82
2. Maintenance .....	82
<b>VIII. Troubleshooting</b> .....	<b>85</b>
1. List of failures .....	85
2. Common troubleshooting .....	88
<b>IX. Appendix 1</b> .....	<b>94</b>

Manufacture reserves the right to discontinue, or change at any time, specifications or designs without notices and without incurring obligations.

---

## **I. Safety precautions**

Before use, read through the operating instructions to ensure proper using. Please keep it well so that the professional technician can refer to it anytime.

### **1. Installation safety considerations**

Access to the unit must be reserved to authorized personnel, qualified and trained in monitoring and maintenance. The access limitation device must be installed by the customer.

After the unit has been received, when it is ready to be installed or reinstalled, and before it is started up, it must be inspected for damage. Check that the refrigerant circuit(s) is (are) intact, especially that no components or pipes have shifted (e.g. following a shock). If in doubt, carry out a leak tightness check and verify with the manufacturer that the circuit integrity has not been impaired. If damage is detected upon receipt, immediately file a claim with the shipping company.

Strongly recommend employing a specialized company to unload the machine.

The units can be lifted with slings, using only the designated lifting points marked on the unit.

Use slings with the correct capacity, and always follow the lifting instructions on the certified drawings supplied with the unit.

Safety is only guaranteed, if these instructions are carefully followed. If this is not the case, there is a risk of material deterioration and injuries to personnel.

Ensure that the valves are correctly installed, before operating the unit.

In certain cases the relief valves are installed on isolating valves. These valves are factory-supplied lead-sealed in the open position. This system permits isolation and removal of the relief valves for checking and replacing. The relief valves are designed and installed to ensure protection against overpressure caused by fire.

Ensure good ventilation, as accumulation of refrigerant in an enclosed space can displace oxygen and cause asphyxiation or explosions.

Inhalation of high concentrations vapour is harmful and may cause heart irregularities, unconsciousness, or death. Vapour is heavier than air and reduces the amount of oxygen available for breathing. These products cause eye and skin irritation. Decomposition products are hazardous

### **2. Maintenance safety considerations**

Engineers working on the electric or refrigeration components must be authorized, trained and fully qualified to do so.

All refrigerant circuit repairs must be carried out by a trained person, fully qualified to work on these units. He must have been trained and be familiar with the equipment and the installation. All welding operations must be carried out by qualified specialists.

Any manipulation (opening or closing) of a shut-off valve must be carried out by a qualified and authorized engineer. These procedures must be carried out with the unit shut-down.

NOTE: The unit must never be left shut down with the liquid line valve closed, as liquid refrigerant can be trapped between this valve and the expansion device. (This valve is situated on the liquid line before the filter drier box.)

During any handling, maintenance and service operations the engineers working on the unit must be equipped with safety gloves, glasses, shoes and protective clothing.

Never work on a unit that is still energized.

Never work on any of the electrical components, until the general power supply to the unit has been cut using the disconnect switch(es) in the control box(es).

---

If any maintenance operations are carried out on the unit, lock the power supply circuit in the open position ahead of the machine.

If the work is interrupted, always ensure that all circuits are still deenergized before resuming the work.

**ATTENTION:**

Even if the unit has been switched off, the power circuit remains energized, unless the unit or circuit disconnect switch is open. Refer to the wiring diagram for further details. Attach appropriate safety labels.

At least once a year thoroughly inspect the protection devices (valves). If the machine operates in a corrosive environment, inspect the protection devices more frequently

### **3. Repair safety considerations**

All installation parts must be maintained by the personnel in charge, in order to avoid material deterioration and injuries to people. Faults and leaks must be repaired immediately.

The authorized technician must have the responsibility to repair the fault immediately. Each time repairs have been carried out to the unit, the operation of the safety devices must be re-checked.

If a leak occurs or if the refrigerant becomes contaminated remove the complete charge using a recovery unit and store the refrigerant in mobile containers.

Repair the leak detected and recharge the circuit with the total R-134a charge, as indicated on the unit name plate polyolester oil.

Do not use oxygen to purge lines or to pressurize a machine for any purpose. Oxygen gas reacts violently with oil, grease, and other common substances.

Never exceed the specified maximum operating pressures. Verify the allowable maximum high- and low-side test pressures by checking the instructions in this manual and the pressures given on the unit name plate.

Don't weld or flame cut the refrigerant pipelines or any refrigerant circuit component until all refrigerant (liquid and gas) has been removed from chiller. Traces of vapour should be displaced with dry air nitrogen. Refrigerant in contact with an open flame produces toxic gases.

The necessary protection equipment must be available, and appropriate fire extinguishers for the system and the refrigerant type used must be within easy reach.

Do not siphon refrigerant.

Avoid spilling liquid refrigerant on skin or splashing it into the eyes. Use safety goggles. Wash any spills from the skin with soap and water. If liquid refrigerant enters the eyes, immediately and abundantly flush the eyes with water and consult a doctor.

Never apply an open flame or live steam to a refrigerant container. Dangerous overpressure can result. If it is necessary to heat refrigerant, use only warm water.

Do not re-use disposable (non-returnable) cylinders or attempt to refill them. It is dangerous and illegal. When cylinders are empty, evacuate the remaining gas pressure, and move the cylinders to a place designated for their recovery. Do not incinerate.

Do not attempt to repair or recondition any safety devices when corrosion or build-up of foreign material (rust, dirt, scale, etc.) is found within the valve body or mechanism.

If necessary, replace the device. Do not install safety valves in series or backwards.

Ensure that you are using the correct refrigerant type before recharging the unit.

Charging any refrigerant other than the original charge type (R-134a) will impair machine operation and can even lead to a destruction of the compressors. The compressors operating with this refrigerant type are lubricated with a synthetic

**ATTENTION:**

No part of the unit must be used as a walkway, rack or support. Periodically check and repair or if necessary replace any component or piping that shows signs of damage.

---

The refrigerant pipelines can break under the weight and release refrigerant, causing personal injury. Do not climb on a machine. Use a platform, or staging to work at higher levels. Use mechanical lifting equipment (crane, hoist, winch, etc.) to lift or move heavy components. For lighter components, use lifting equipment when there is a risk of slipping or losing your balance. Use only original replacement parts for any repair or component replacement. Consult the list of replacement parts that corresponds to the specification of the original equipment. Do not drain water circuits containing industrial brines, without informing the technical service department at the installation site or a competent body first. Close the entering and leaving water shutoff valves and purge the unit water circuit, before working on the components installed on the circuit (screen filter, pump, water flow switch, etc.). Do not loosen the water box bolts until the water boxes have been completely drained. Periodically inspect all valves, fittings and pipes of the refrigerant and hydronic circuits to ensure that they do not show any corrosion or any signs of leaks. It is recommended to wear ear defenders, when working near the unit and the unit is in operation.



**INTENSITY**<sup>®</sup>  
Refresh your life

## II. Product

### 1. General Information

#### 1). Product line up

Model	Power Supply	Cooling Capacity (kW)	Quantity of Compressor	Quantity of Fan
LSBLGW380/C	460V/3Ph/60Hz	376	1	6
LSBLGW500/C	460V/3Ph/60Hz	496	1	8
LSBLGW600/C	460V/3Ph/60Hz	594	1	10
LSBLGW720/C	460V/3Ph/60Hz	720	1	10
LSBLGW900/C	460V/3Ph/60Hz	902	2	14
LSBLGW1000/C	460V/3Ph/60Hz	996	2	16
LSBLGW1200/C	460V/3Ph/60Hz	1203	2	16
LSBLGW1420/C	460V/3Ph/60Hz	1419	2	20

#### 2). Nomenclature

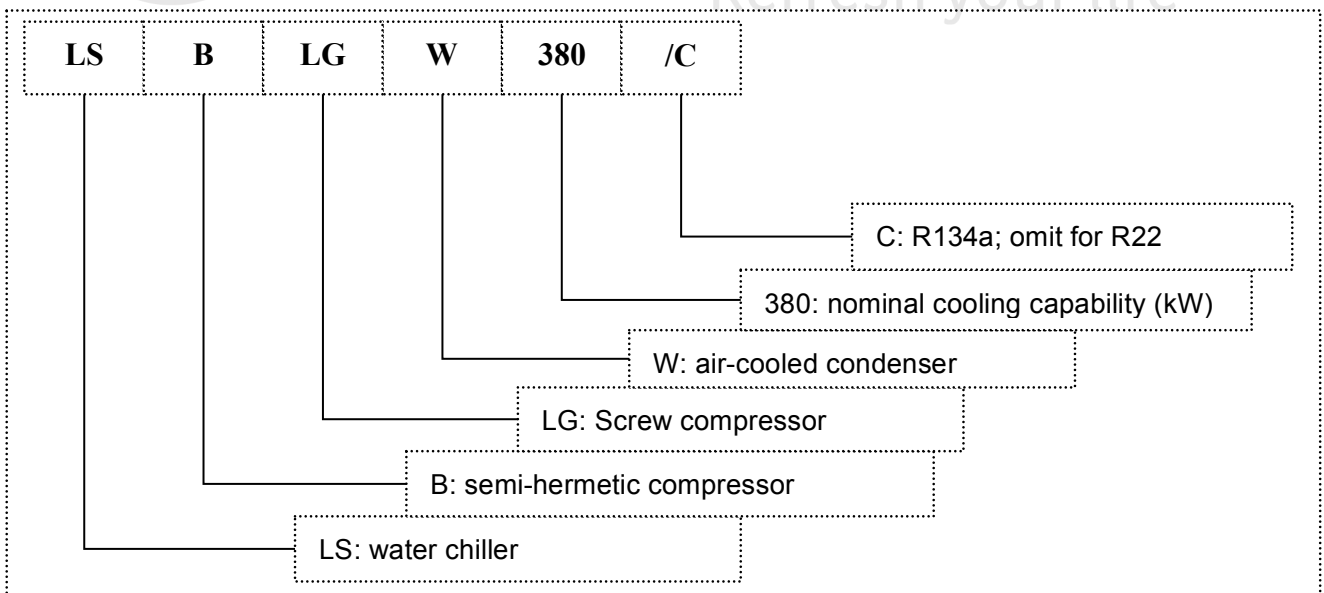

### 3). External appearance



LSBLGW380/C module



LSBLGW500/C module

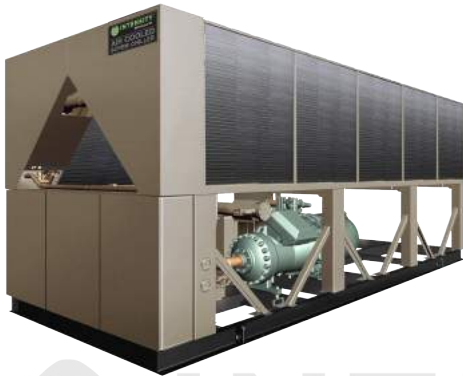

LSBLGW600/C

LSBLGW720/C module

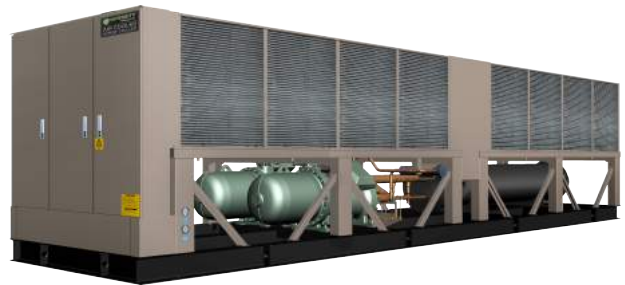

LSBLGW900/C module



LSBLGW1000/C LSBLGW1200/C module



LSBLGW1420/C module

## 2. Feature

### Environmental care

- R134a refrigerant  
Refrigerant of the HFC group with zero ozone depletion potential.  
It is environmentally safe and does not have a phase-out date.



### Economical operation cost

- Extremely high full load and partial load energy efficiency. New twin-rotor screw compressor equipped with a high-efficiency motor and a variable capacity valve that can adjust the capacity of 25%, 50%, 75% and 100% in 4 stages (Stepless control is optional) and permits exact matching of the cooling capacity to the actual load.
- Electronic expansion device permits the operation at a lower condensing pressure and improve the utilization of the evaporator heat exchange surface (superheat control).
- Economizer system with electronic expansion device for increases the cooling capacity. Automatic scheduling of the Chiller's compressors allows the chiller to match the fluctuating cooling load and conserve energy with each unit running at its peak efficiency.

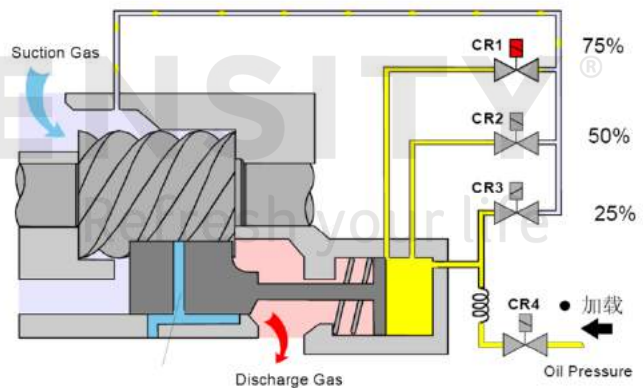

### Lower operating noise

- The twin-screw compressor adopts the strong points of gapless-loss, high-efficiency cubage, low-noise, few easy workout parts. Double-wall structure not only compensates the pressure, but also significantly reduces the noise. Cast iron structure of the compressor casing and oil separator can reduce the noise significantly.

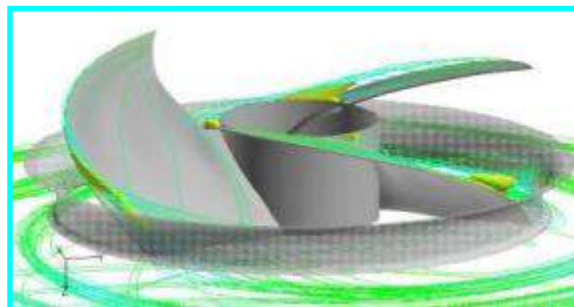

- Low-noise fans, made of a composite material are now even quieter and do not generate intrusive low-frequency noise. Rigid fan mounting avoids start-up noise.  
Multiple direct drive dynamically balanced propeller fans operate at low tip speeds for maximum



---

efficiency and minimum noise and vibration. A heavy-gauge vinyl-coated fan guard protects each fan.

### **Outstanding reliability**

- Full factory testing of all the units ensures a trouble free start-up. Extensive test makes certain that each safety and operating control is properly adjusted, and operates correctly. The unit has passed full factory test before being delivered to ensure the reliable working on the site.
- Transport simulation test in the laboratory on a vibrating table.

### **Simple structure, easy Installation**

- The unit can be placed in service after being connected with power supply and water supply during field installation .Standard flange connection and wire mesh to the electrical panel make the installation easy and simple.



### **State of technique, accuracy control**

- The sensors related to control and other assemblies are equipped by factory and strictly tested  
Intelligent control: The unit is controlled by micro-controller and has the automatic control functions of fault diagnosis, energy management and anti-freezing monitoring, which ensures the high-efficiency operation of the unit, and more convenient in use. The unit with RS485 open protocol communication interface. BMS compatible. The startup and shutdown of each unit is controlled by the host computer, reducing the running cost to the lowest.
- Complete and safe control system: All electrically control elements are designed and selected with stable quality and reliable function; The unit designed with multiple security measures ensure the safe and reliable running witch including high and low pressure protection, oil pressure difference protection, anti-freezing protection, water flow protection, power protection, overload protection etc.

### 3. Specification

#### Single compressor:

LSBLGWXXX/C		380	500	600	720
Cooling capacity	kW	376	496	594	720
Power input	kW	124	159	187	234
COP	kW/kW	3.03	3.12	3.17	3.07
Semi-hermetic screw compressor					
Circuit A	Quantity	1	1	1	1
Circuit B	Quantity	--	--	--	--
Oil recharge	Type	BSE170	BSE170	BSE170	BSE170
Circuit A	L	30	30	30	32
Circuit B	L	--	--	--	--
Refrigerant	Type	R134a	R134a	R134a	R134a
Circuit A	kg	76	90	105	140
Circuit B	kg	--	--	--	--
Control Type		EXV	EXV	EXV	EXV
Evaporator	Type	Shell_tube heat exchanger(DX)			
Water content	L	222	308	340	520
Water flow	m <sup>3</sup> /h	65.4	86	103.2	123.8
Pressure drop	kPa	39	54	56	58
Max. pressure	MPa	1	1	1	1
Pipe connection type		Victaulic Coupling			
Water inlet/outlet pipe dim.	mm	125	125	125	150
Condenser	Type	Fin-coil	Fin-coil	Fin-coil	Fin-coil
Fan	Quantity	6	8	10	10
Total air flow	m <sup>3</sup> /h	23000*6	23000*8	23000*10	23000*10
Fan speed	rpm	860	860	860	860
Unit length	mm	3810	4680	5800	5800
Unit width	mm	2280	2280	2280	2280
Unit height	mm	2370	2370	2370	2370
Shipping weight	kg	3320	4330	5000	5500
Running weight	kg	3540	4640	5340	6020

#### Note:

1) Nominal cooling capacities are based on the following conditions:

Chilled water inlet/outlet temp: 12°C/7°C; Outdoor temp (DB/WB):35°C/24°C.

2) The applicable ambient temperature range of R134a air-cooled screw units is 15°C ~ 43°C.

3) Water side fouling factor: 0.086m<sup>2</sup>·°C/kW.

## Dual compressors:

LSBLGWXXX/C		900	1000	1200	1420
Cooling capacity	kW	902	996	1203	1419
Power input	kW	285	318	381	466
COP	kW/kW	3.16	3.13	3.15	3.04
Semi-hermetic screw compressor					
Circuit A	Quantity	1	1	1	1
Circuit B	Quantity	1	1	1	1
Oil recharge	Type	BSE170	BSE170	BSE170	BSE170
Circuit A	L	30	30	30	32
Circuit B	L	30	30	30	32
Refrigerant	Type	R134a	R134a	R134a	R134a
Circuit A	kg	76	90	105	140
Circuit B	kg	90	90	105	140
Control Type		EXV	EXV	EXV	EXV
Evaporator	Type	Shell_tube heat exchanger(DX)			
Water content	L	620	600	770	910
Water flow	m <sup>3</sup> /h	154.8	172	206.4	244.2
Pressure drop	kPa	74	75	71	69
Max. pressure	MPa	1	1	1	1
Pipe connection type		Victaulic Coupling			
Water inlet/outlet pipe dim.	mm	150	150	200	200
Condenser	Type	Fin-coil	Fin-coil	Fin-coil	Fin-coil
Fan	Quantity	14	16	16	20
Total air flow	m <sup>3</sup> /h	23000*14	23000*16	23000*16	23000*20
Fan speed	rpm	860	860	860	860
Unit length	mm	8800	9640	9640	11700
Unit width	mm	2280	2280	2280	2280
Unit height	mm	2430	2430	2430	2430
Shipping weight	kg	7750	8900	9100	11100
Running weight	kg	8370	9500	9870	12010

### Note:

1) Nominal cooling capacities are based on the following conditions:

Chilled water inlet/outlet temp: 12°C/7°C; Outdoor temp (DB/WB):35°C/24°C.

2) The applicable ambient temperature range of R134a air-cooled screw units is 15°C ~ 43°C.

3) Water side fouling factor: 0.086m<sup>2</sup>·°C/kW.

#### 4. Outline dimension

(1) LSBLGW380/C

Unit (mm)

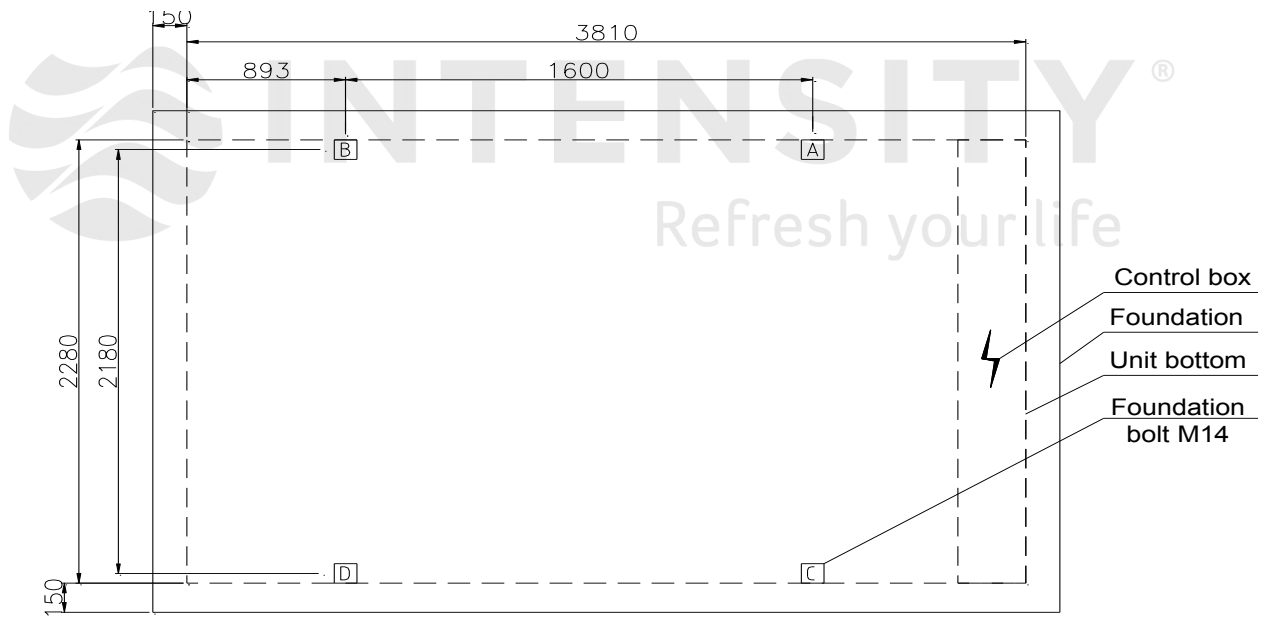
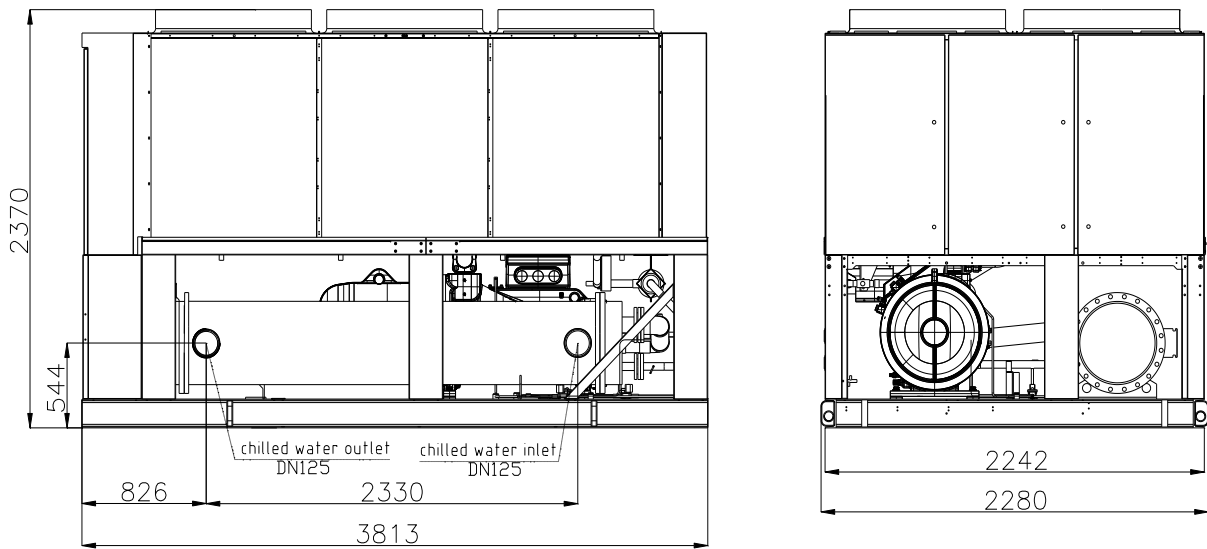

Model	Weight to be supported by spring isolator(kg)			
	A	B	C	D
LSBLGW380/C	869	901	869	901

(2) LSBLGW500/C

Unit (mm)

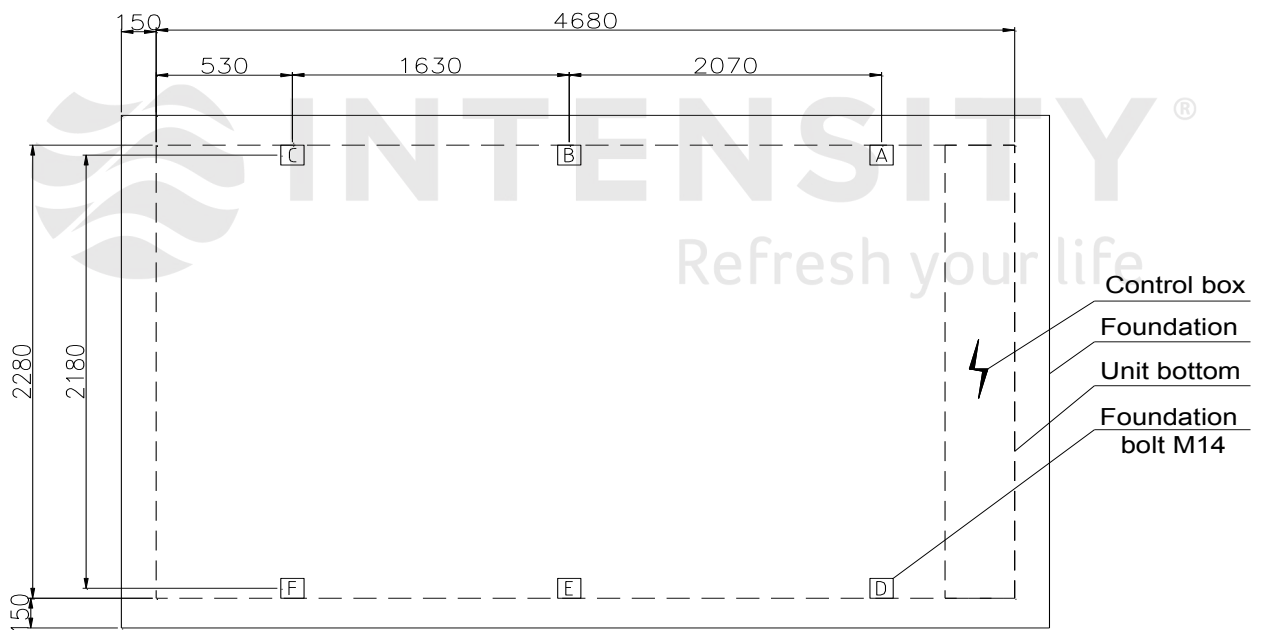
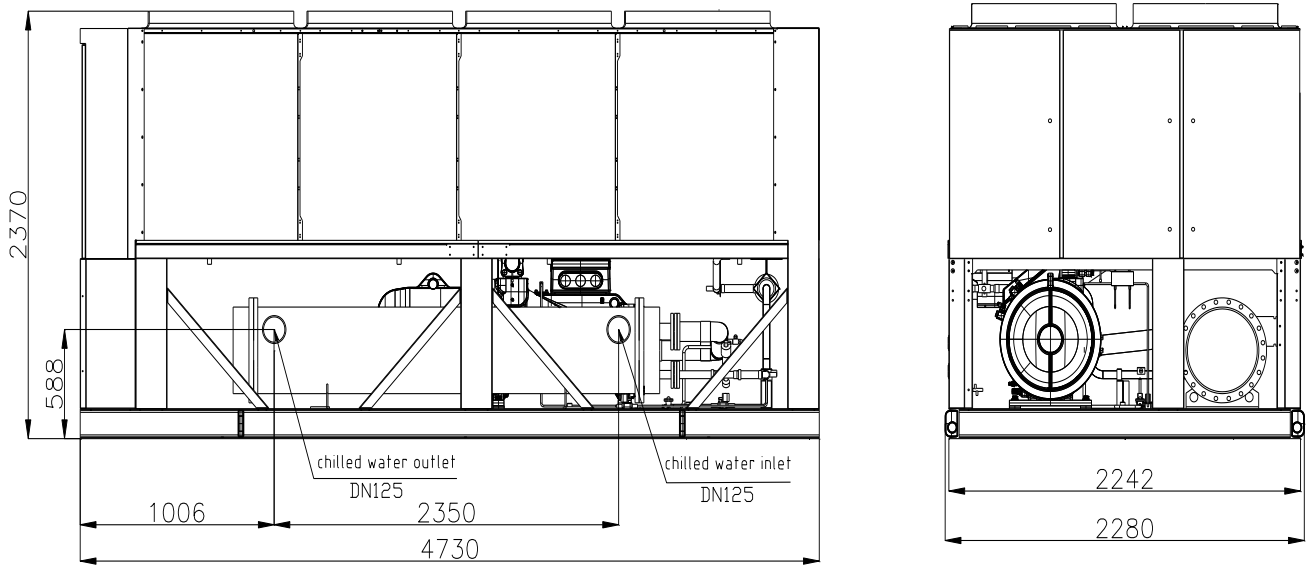

Model	Weight to be supported by spring isolator(kg)					
	A	B	C	D	E	F
LSBLGW500/C	633	855	832	633	855	832

(3) LSBLGW600/C

Unit(mm)

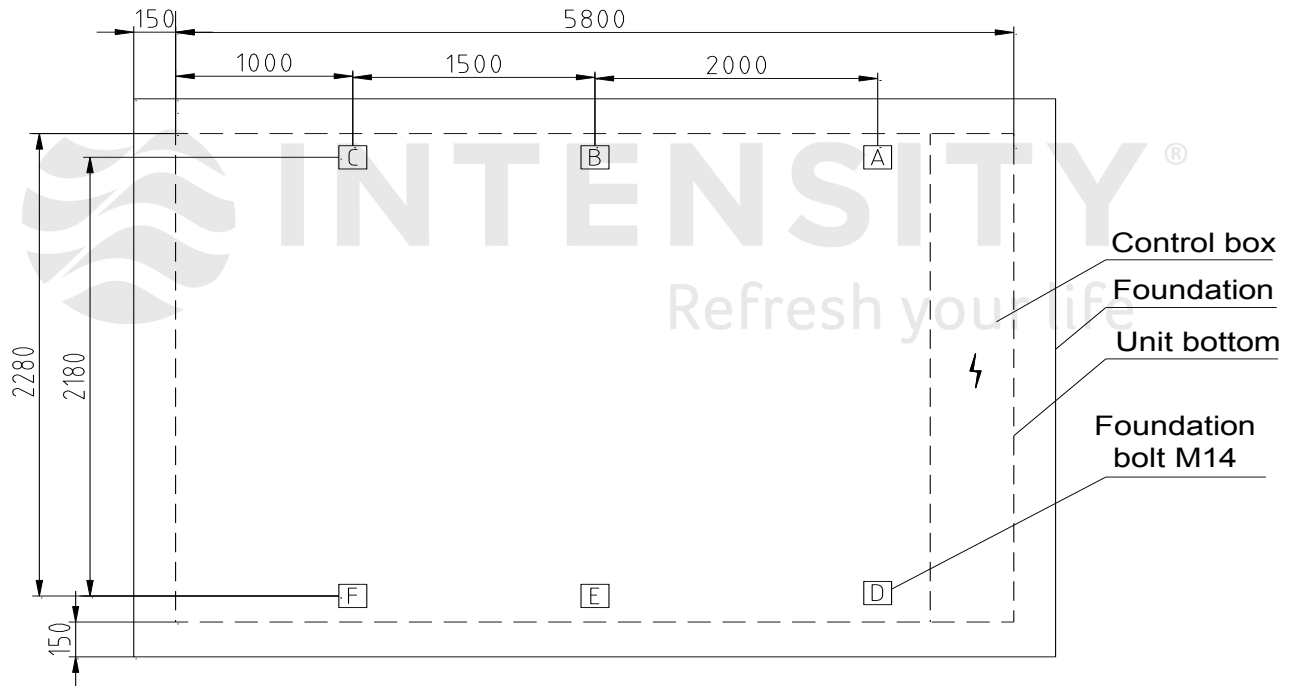
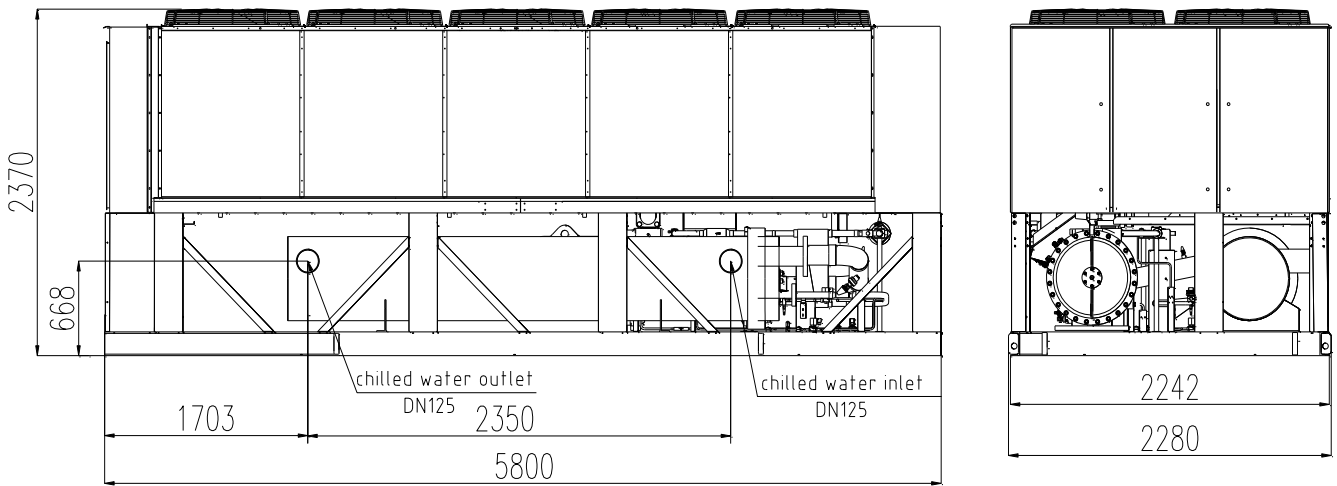

Model	Weight to be supported by spring isolator(kg)					
	A	B	C	D	E	F
LSBLGW600/C	815	934	921	815	934	921

(4) LSBLGW720/C

Unit(mm)

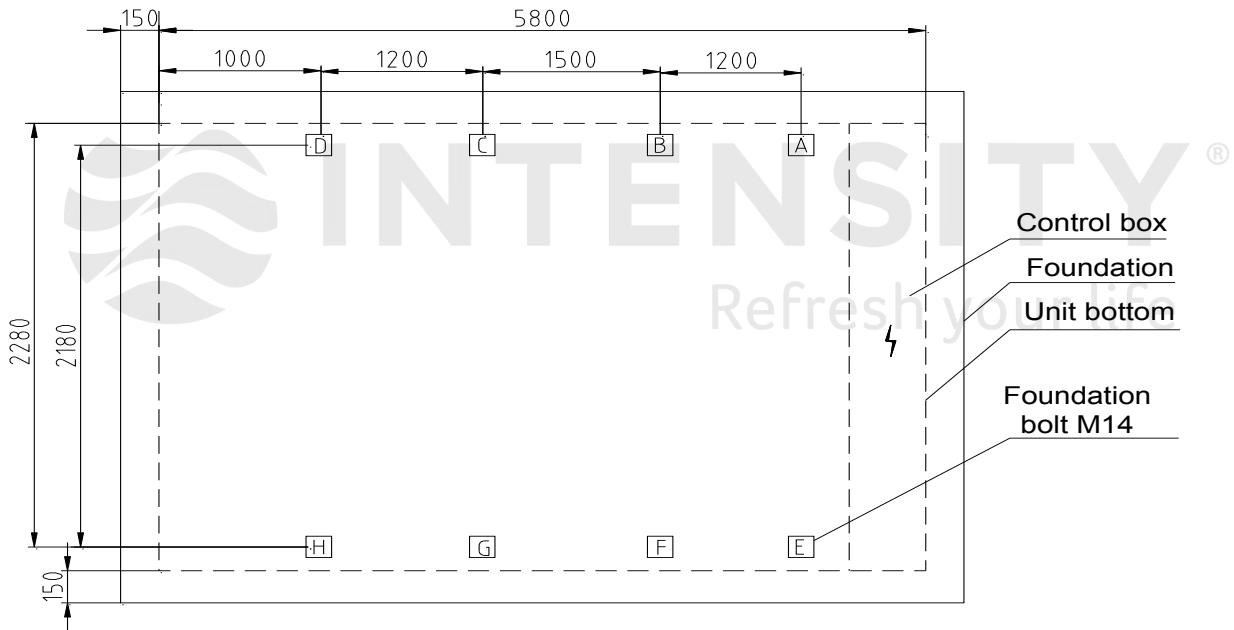
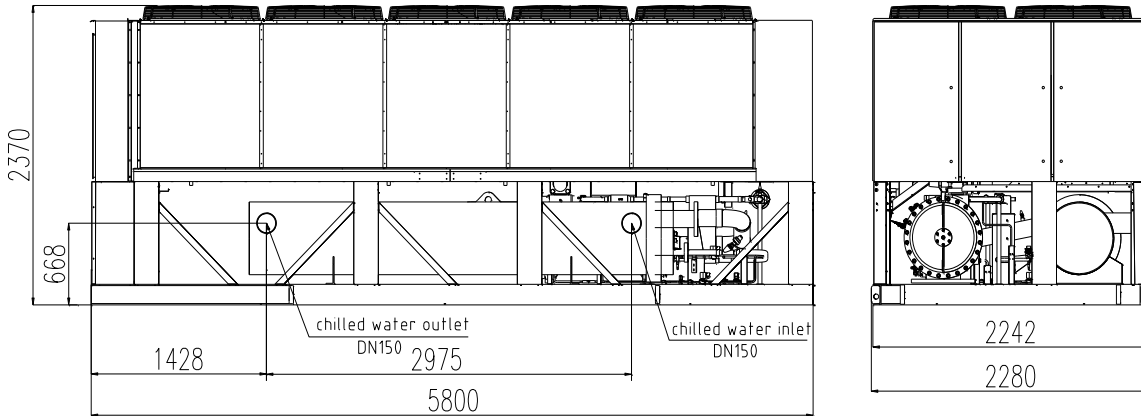

Model	Weight to be supported by spring isolator(kg)							
	A	B	C	D	E	F	G	H
LSBLGW720/C	687	765	800	758	687	765	800	758

(5) LSBLGW900/C unit

Unit(mm)

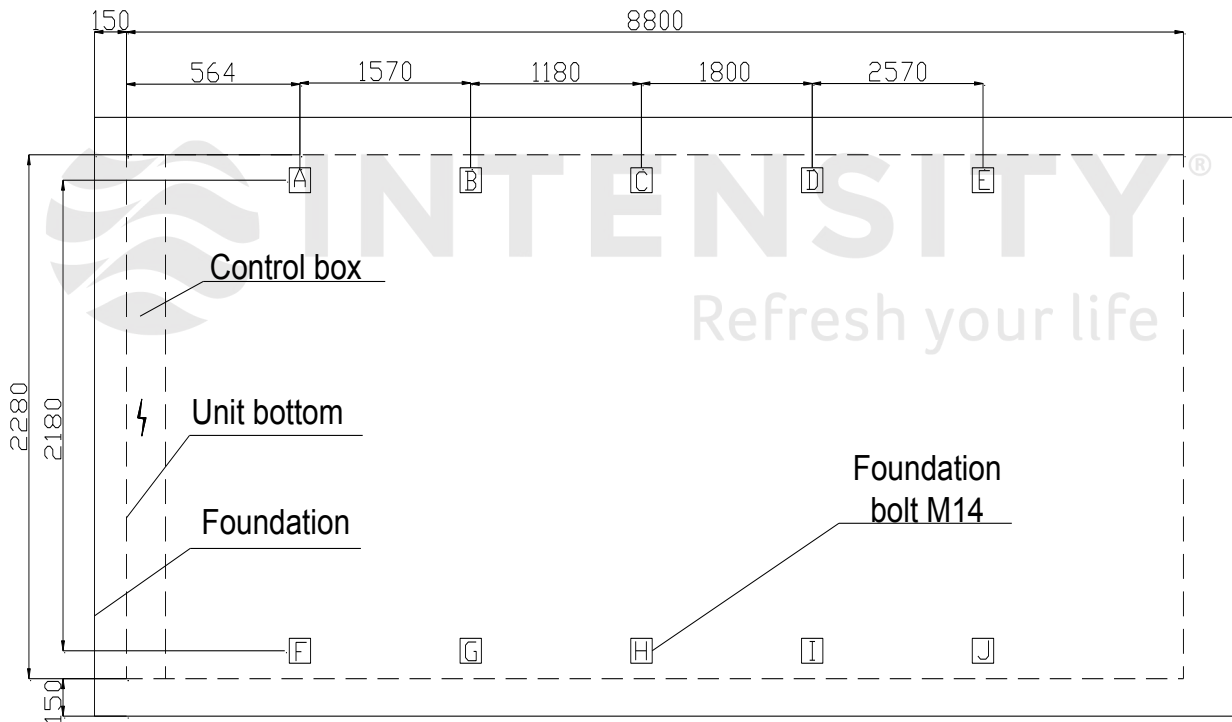
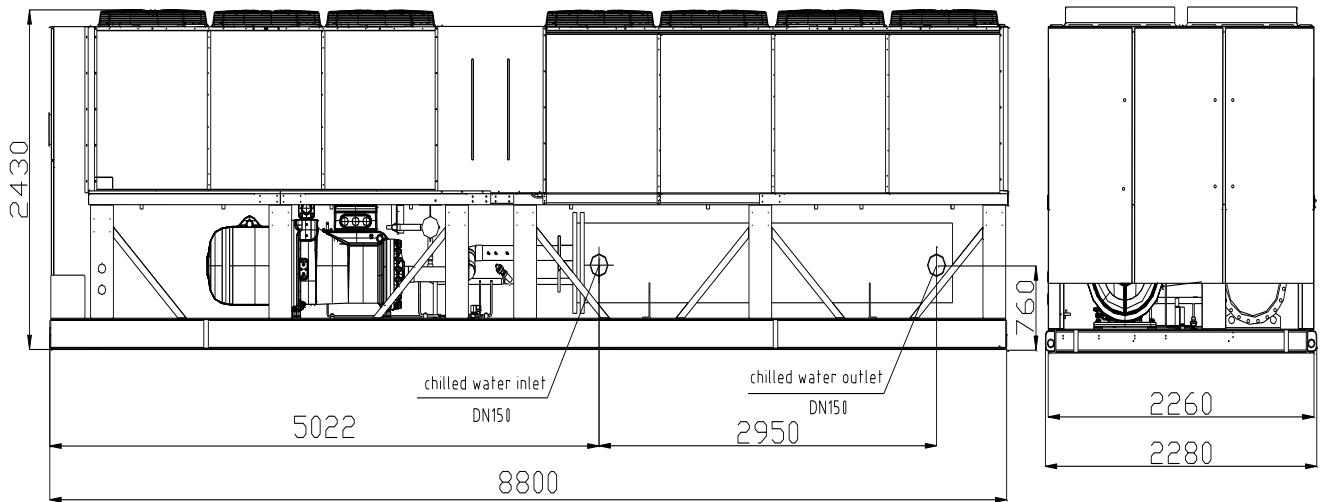

Model	Weight to be supported by spring isolator ( kg )									
	A	B	C	D	E	F	G	H	I	J
LSBLGW900/C	814	944	947	747	733	814	944	947	747	733



(6) LSBLGW1000/C

Unit(mm)

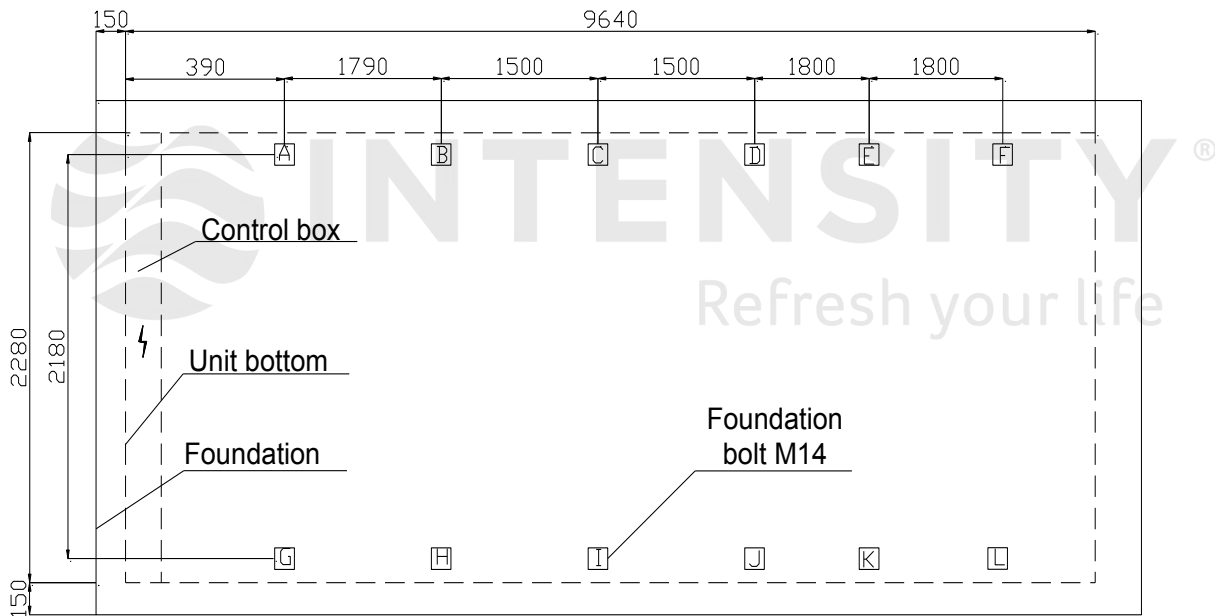
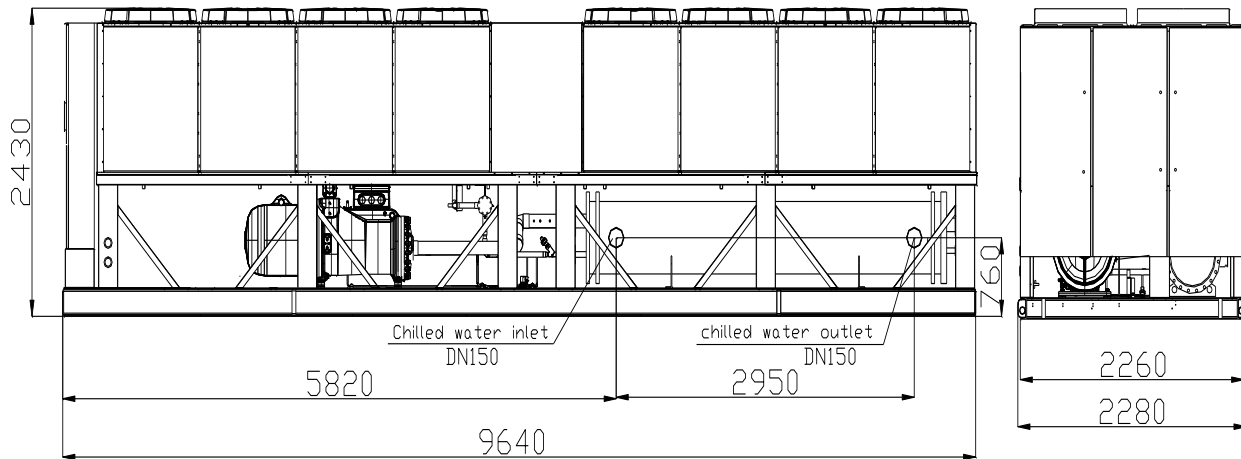

Model	Weight to be supported by spring isolator ( kg )											
	A	B	C	D	E	F	G	H	I	J	K	L
LSBLGW1000/C	726	912	917	732	731	732	726	912	917	732	731	732

(7) LSBLGW1200/C

Unit(mm)

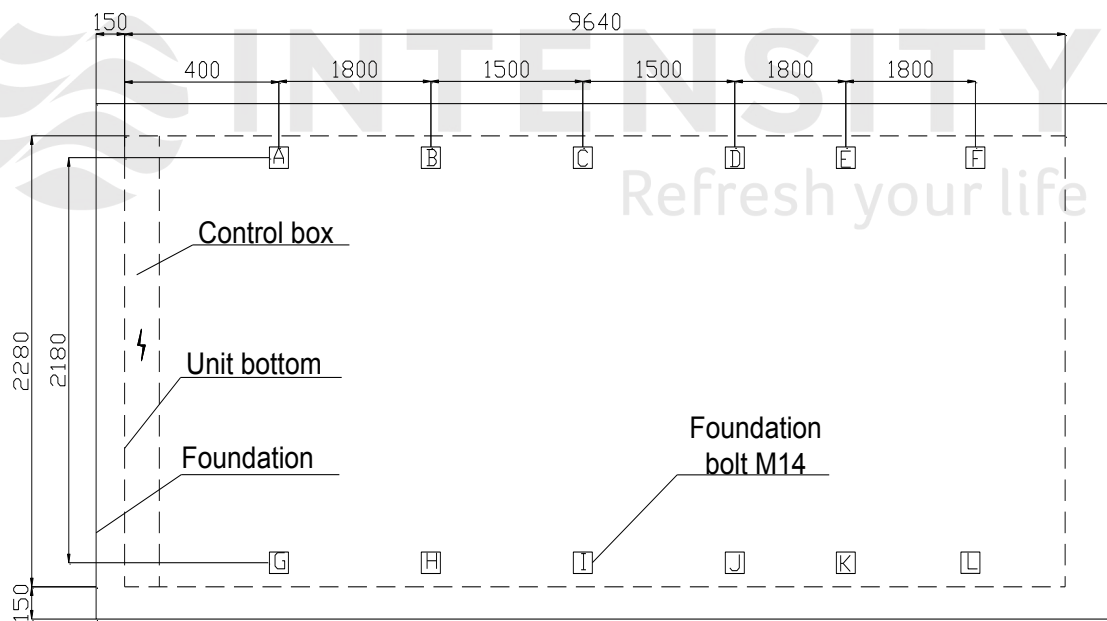
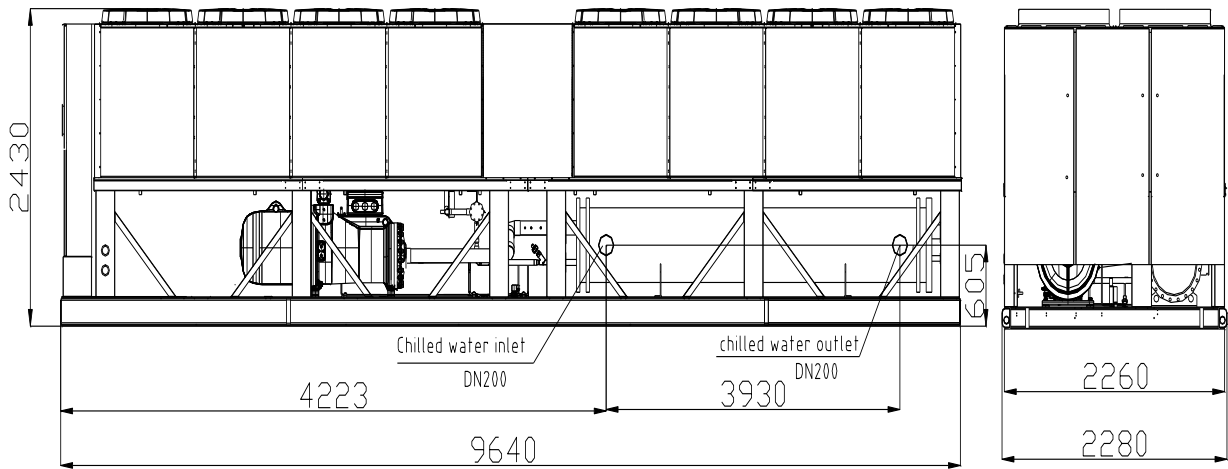

Model	Weight to be supported by spring isolator ( kg )											
	A	B	C	D	E	F	G	H	I	J	K	L
LSBLGW1200/C	789	912	905	779	777	773	789	912	905	779	777	773

**(8) LSBLGW1420/C**

Unit(mm)

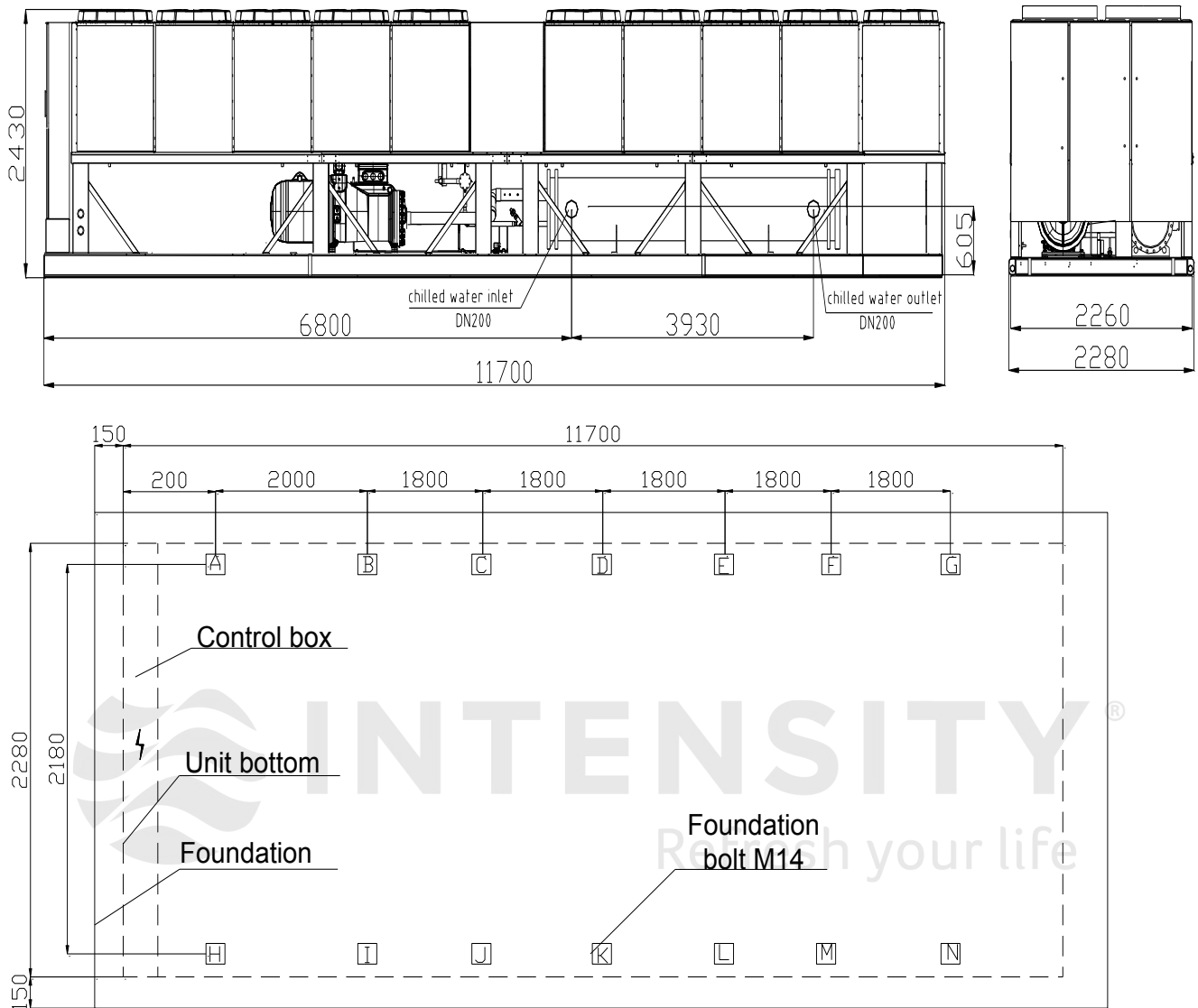

Model	Weight to be supported by spring isolator ( kg )													
	A	B	C	D	E	F	G	H	I	J	K	L	M	N
LSBLGW1420/C	794	925	954	936	800	798	798	794	925	954	936	800	798	798

## 5. Refrigeration system

### 1). Refrigeration system diagram

380/500/600/720kW

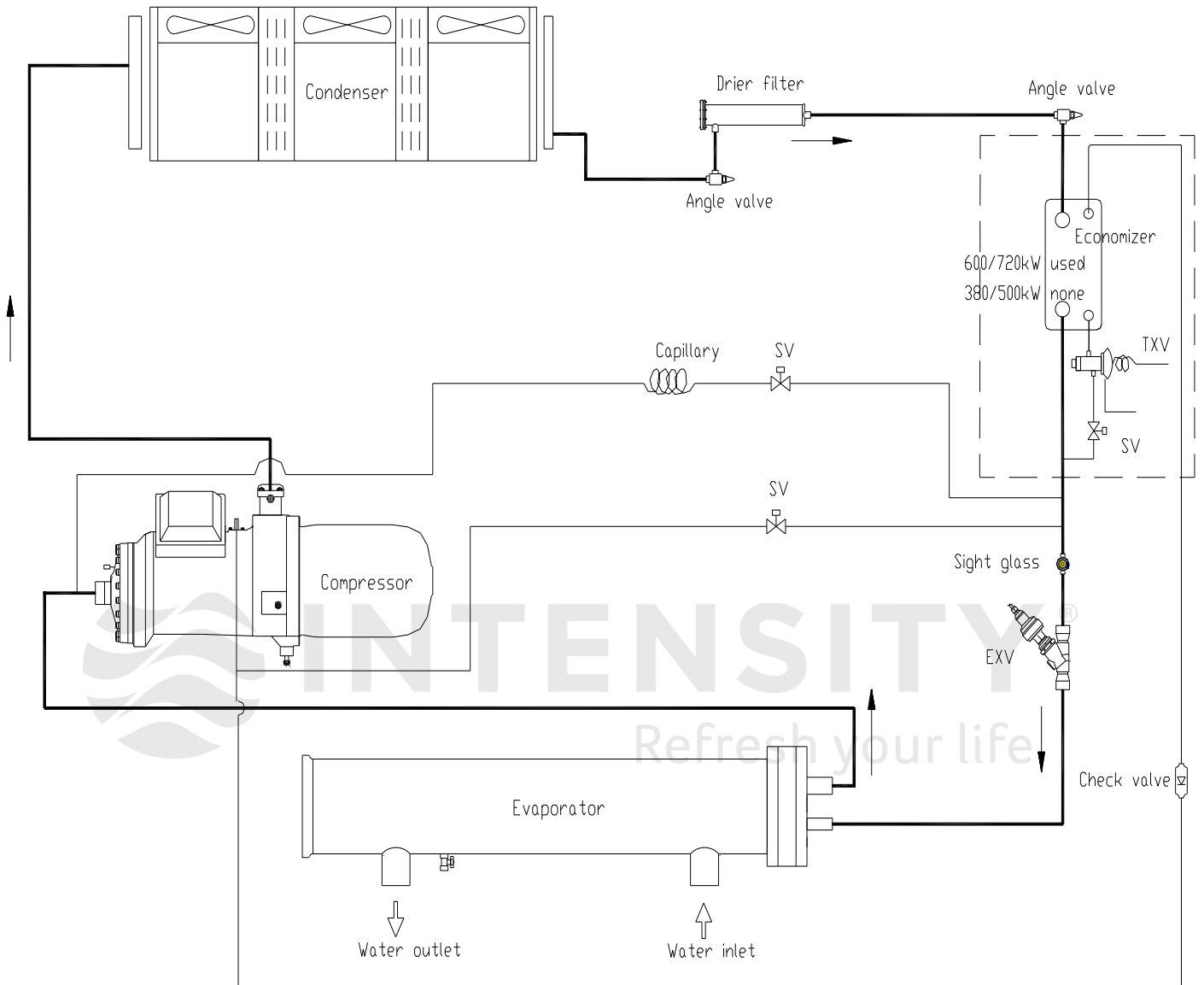

900/1000/1200/1420kW

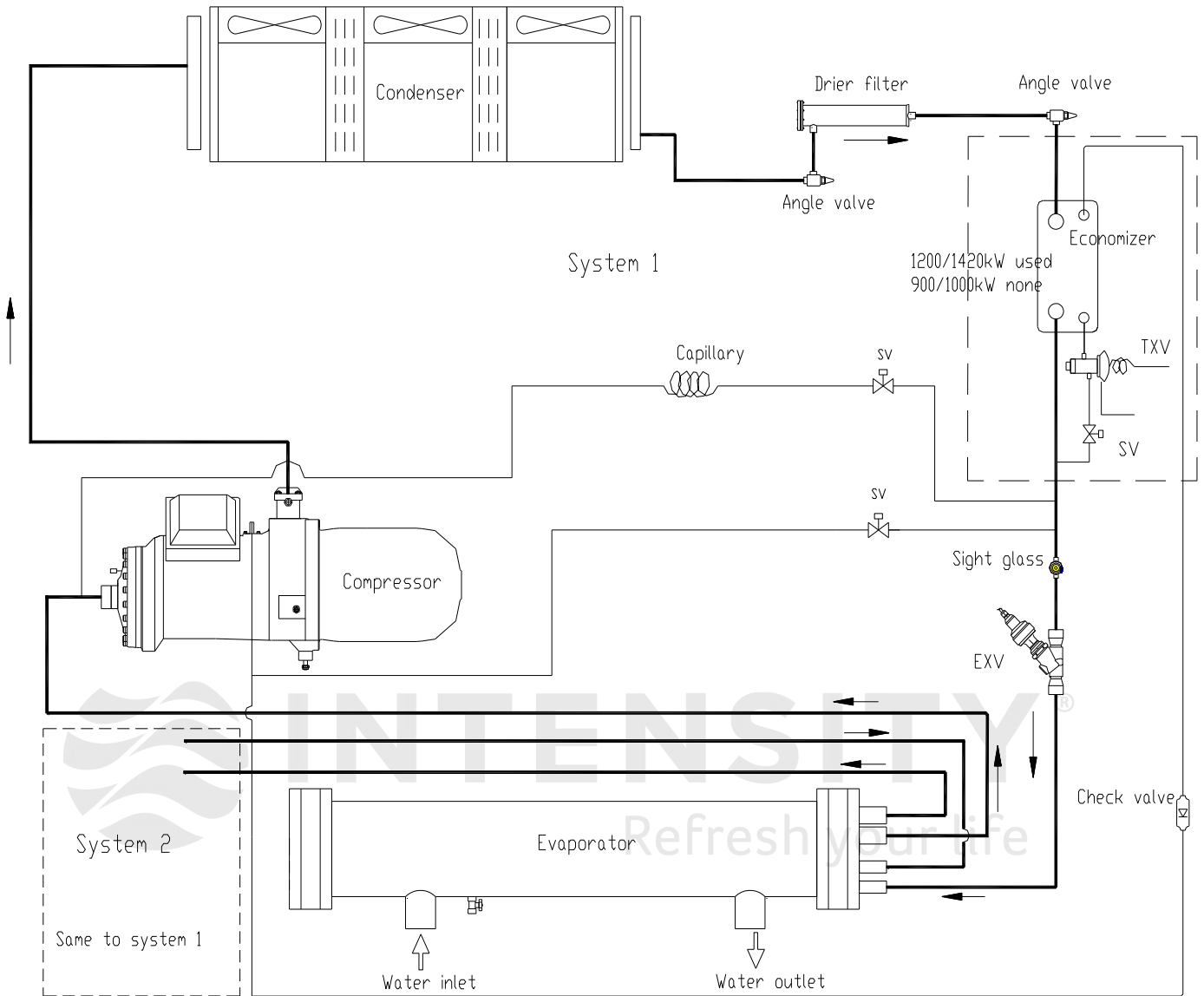

## 6. Key parts list

No	Name	Picture	Model	Brand	
1	Compressor		CSH series	Bitzer	Germany
4	Fan		RZLC-9.0P3 0S6BGE-C	RAINBOW	China
5	Drier filter		SRA Series	LIANGJIANG	China
7	Electric expansion valve		ETS250	Danfoss	Denmark
8	Solenoid valve		FDF8MJ-10	STF	China
12	Safety valve		SFV25 T325(2416+ 187)	Danfoss	Denmark

## 7. Application

### 1).Operating Range

Content	Running range
Ambient Temp.	15°C~43°C(T1)
Leaving water Temp.	5°C~15°C
Water flow volume	Rating flow volume±20%
Max inlet/outlet water Temp. difference	8°C
Fouling factor (m <sup>2</sup> ·°C/kW)	0.086
Voltage tolerance	Rating Voltage±10%
Phase tolerance	±2%
Power supply frequency	Rating frequency±2%
Evaporator max working pressure on water side	1.0MPa
Compressor max. start count	4 times/h
Environment quality	High corrosive environment and high humidity should be avoided.
Drainage system	The height of water drainage should not be higher than the base of the unit on the spot
Storage and transport temperature	-25°C~55°C
RH(relative air humidity)	In + 40°C does not exceed 50%, + 25°C no more than 90%
Applicable altitude range:	No more than 1000m

### 2).Water Flow – Water Drop Pressure Curve

Balance the chilled water flow through the evaporator. The flow rates must fall between the minimum and maximum values shown in the below table. Flow rates below the minimum values shown will result in laminar flow which will reduce efficiency, cause erratic operation of the electronic expansion valve and could cause low temperature cutouts. On the other hand, flow rates exceeding the maximum values shown can cause erosion on the evaporator water connections and tubes, even piping breaking.

Variable chilled water flow through the evaporator while the compressor(s) are operating is not recommended. The chiller control set points are based upon a constant flow and variable temperature.

Unit Model	MIN. FLOW RATE		MAX. FLOW RATE		
	SIZE	m <sup>3</sup> /h	GPM	m <sup>3</sup> /h	GPM
LSBLGW380/C		53	233	79	348
LSBLGW500/C		69	304	104	458
LSBLGW600/C		83	365	124	546
LSBLGW720/C		99	436	149	656
LSBLGW880/C		124	546	186	819
LSBLGW1000/C		138	608	207	912

LSBLGW1200/C	165	727	248	1092
LSBLGW1420/C	196	863	293	1290

**Evaporator Water Pressure Drop Curve**

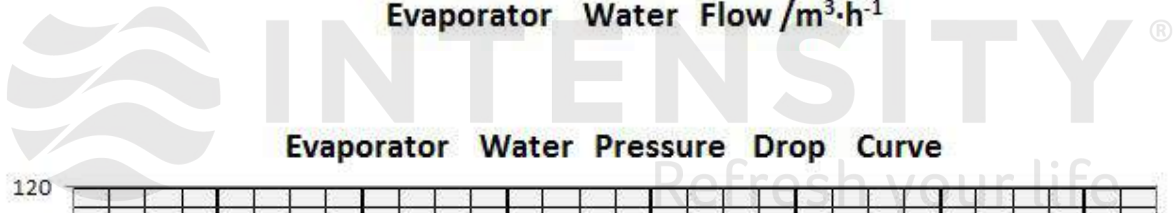
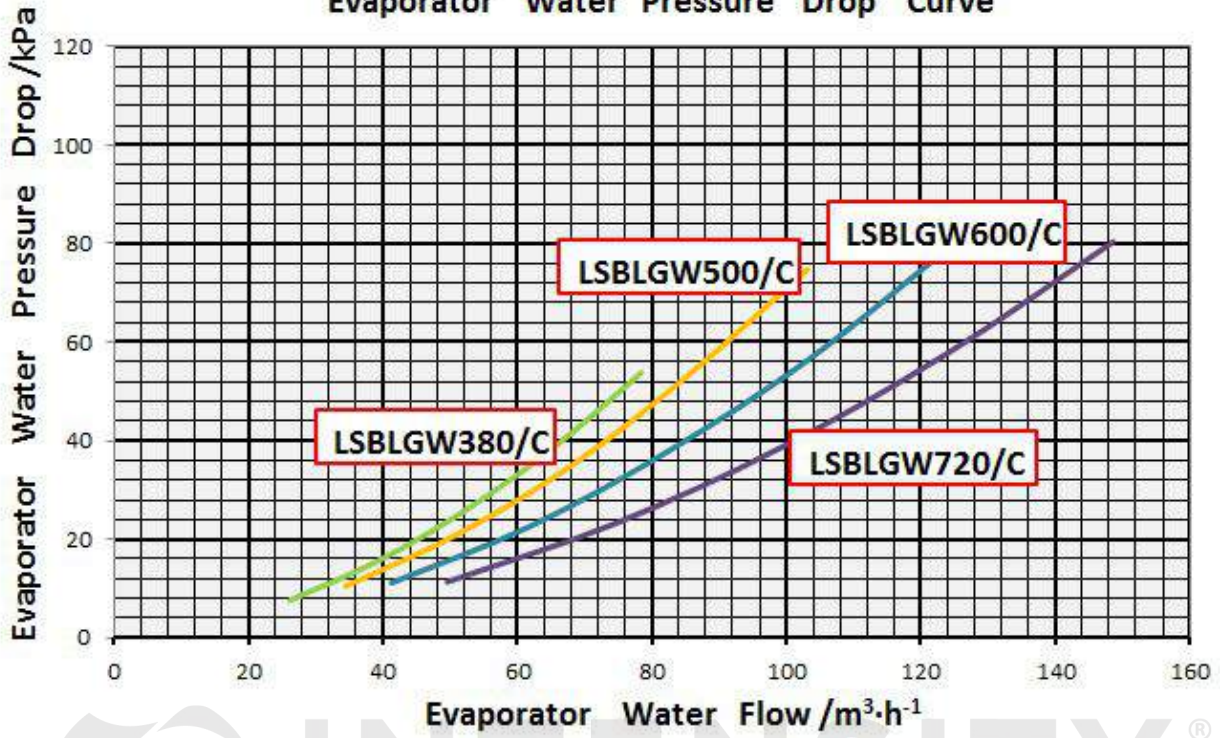

**Evaporator Water Pressure Drop Curve**

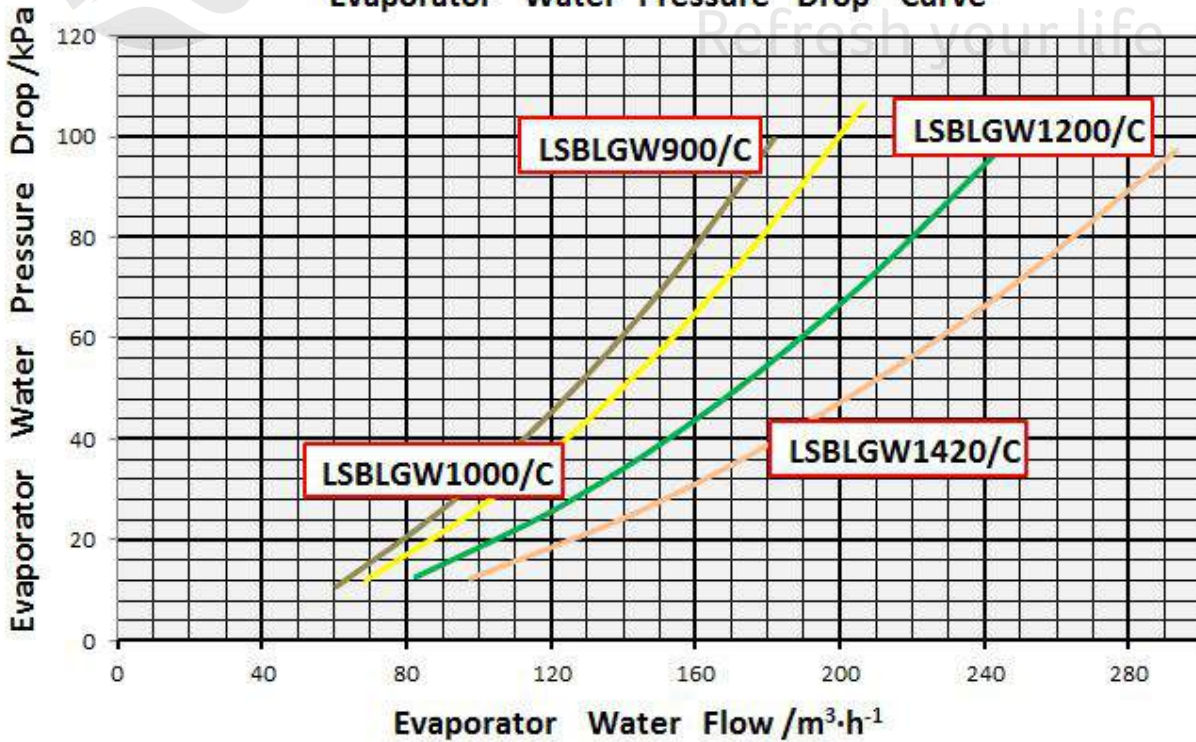



---

### 3).Minimum volume in pipeline system

How to calculate minimum volume in pipeline system:

$$W=QgT/CP\Delta t$$

W — Minimum water volume (kg) ;

Qg — Total cooling/heating capacity of the terminal (kW) ;

T — Thermal stability time requirement, Take (8~10) ×60s;

CP — Water specific heat at constant pressure, 4.187kj/ (kg·°C) ;

$\Delta t$  — Water temperature fluctuation required value, take 5°C。

For system, Qg is calculated according to the lowest load so that it operates steadily.

It can also be calculated according to 0.5Q(50%). T takes 8 minutes, the shortest time that the unit running.

That is 480s. Cp=4.18kj/kg,  $\Delta t$  =5°C。

According to the above formula, the result is as following:

$$W=0.5Q*480/ (4.18*5) =11.48Q \text{ kg}$$

**Note:**

The above formula is only for reference, different factor should be adopted to suit for different condition.



**INTENSITY**®

Refresh your life

## 8. Capacity table

Model	Outlet Temp.	Ambient temperature													
		15		20		25		30		35		40		43	
		Cooling Capacity /kW	Power Input /kW	Cooling Capacity /kW	Power Input /kW	Cooling Capacity /kW	Power Input /kW	Cooling Capacity /kW	Power Input /kW	Cooling Capacity /kW	Power Input /kW	Cooling Capacity /kW	Power Input /kW	Cooling Capacity /kW	Power Input /kW
380	5	418.0	93.0	397.3	101.4	380.6	108.1	362.3	115.7	349.8	120.8	324.3	130.8	310.1	137.1
	6	436.0	94.5	414.3	103.0	396.6	109.7	376.9	117.3	362.5	122.4	337.5	132.6	322.0	138.8
	7	453.9	96.0	431.3	104.5	412.6	111.3	392.0	119.0	376.0	124.0	350.6	134.3	334.5	140.6
	8	471.9	97.5	448.3	106.1	428.6	112.9	407.0	120.6	390.7	125.8	363.8	136.1	347.1	142.4
	9	489.8	99.0	465.3	107.6	444.7	114.5	422.1	122.3	404.8	127.5	376.9	137.8	359.7	144.2
	10	507.8	100.4	482.3	109.2	460.7	116.1	437.2	123.9	417.2	129.0	390.1	139.6	370.7	145.7
	11	525.8	101.9	499.3	110.7	476.7	117.7	452.2	125.6	433.1	131.0	403.2	141.4	384.9	147.7
	12	543.7	103.4	516.3	112.2	492.8	119.3	467.3	127.2	447.2	132.7	416.3	143.1	397.5	149.5
	13	561.7	104.9	533.3	113.8	508.8	120.9	482.3	128.9	461.3	134.4	429.5	144.9	410.0	151.3
	14	579.6	106.4	550.3	115.3	524.8	122.5	497.4	130.6	475.4	136.1	442.6	146.7	422.6	153.1
15	597.6	107.9	567.3	116.9	540.8	124.1	512.5	132.2	490.5	138.0	455.8	148.4	436.0	155.0	
500	5	527.4	120.7	504.5	131.3	489.1	139.4	470.0	148.9	461.8	154.7	431.7	167.6	413.1	175.3
	6	552.2	122.1	527.8	132.8	510.5	141.2	489.6	150.7	478.4	156.8	447.9	169.8	428.7	177.8
	7	576.9	123.4	551.1	134.3	532.3	143.0	509.9	152.7	496.0	159.0	465.3	172.3	445.4	180.3
	8	601.6	124.7	574.5	135.8	554.0	144.7	530.3	154.7	515.6	161.5	482.7	174.7	462.2	182.8
	9	626.3	126.0	597.8	137.3	575.8	146.5	550.6	156.7	534.3	163.8	500.1	177.2	478.9	185.3
	10	651.0	127.3	621.2	138.8	597.6	148.3	570.9	158.7	550.5	165.8	517.5	179.6	493.2	187.5
	11	675.7	128.7	644.5	140.3	619.4	150.0	591.2	160.7	571.5	168.5	535.0	182.1	512.4	190.4
	12	700.4	130.0	667.8	141.8	641.2	151.8	611.6	162.7	590.2	170.8	552.4	184.5	529.2	192.9
	13	725.0	131.3	691.2	143.3	663.0	153.6	631.9	164.7	608.8	173.2	569.8	187.0	545.9	195.4
	14	749.7	132.6	714.5	144.8	684.7	155.3	652.2	166.7	627.4	175.5	587.2	189.4	562.6	197.9
15	774.3	133.9	737.9	146.4	706.9	157.1	673.3	168.8	647.5	178.0	605.9	192.1	580.6	200.6	

Note: The inlet/outlet water temperature difference is 5°C.

Model	Outlet Temp.	Ambient temperature													
		15		20		25		30		35		40		43	
		Cooling Capacity /kW	Power Input /kW	Cooling Capacity /kW	Power Input /kW	Cooling Capacity /kW	Power Input /kW	Cooling Capacity /kW	Power Input /kW	Cooling Capacity /kW	Power Input /kW	Cooling Capacity /kW	Power Input /kW	Cooling Capacity /kW	Power Input /kW
600	5	634.0	133.6	609.2	147.7	591.0	159.7	569.4	172.7	557.4	182.6	526.4	198.7	507.2	208.6
	6	653.3	135.9	627.9	150.1	609.5	162.0	587.5	175.1	575.2	184.8	543.7	201.2	524.0	211.1
	7	674.0	138.5	647.9	152.8	629.3	164.6	606.9	177.6	594.0	187.0	562.2	203.7	541.8	213.8
	8	694.6	141.2	667.9	155.5	649.1	167.2	626.3	180.2	614.5	189.5	580.7	206.3	559.7	216.5
	9	715.3	143.8	687.9	158.2	668.9	169.8	645.7	182.8	634.1	191.9	599.3	208.8	577.5	219.2
	10	735.9	146.4	705.4	160.2	688.7	172.4	665.1	185.4	651.3	194.0	617.8	211.4	593.2	221.6
	11	756.6	149.1	727.9	163.5	708.5	175.0	684.4	188.0	673.4	196.6	636.3	213.9	613.2	224.5
	12	777.2	151.7	747.9	166.2	728.3	177.6	703.8	190.6	693.1	199.0	654.9	216.5	631.1	227.2
	13	797.9	154.3	767.9	168.9	748.1	180.2	723.2	193.1	712.8	201.3	673.4	219.0	648.9	229.9
	14	818.5	157.0	787.9	171.6	767.9	182.8	742.6	195.7	732.4	203.7	691.9	221.6	666.8	232.6
	15	840.6	159.9	809.2	174.6	789.0	185.4	763.2	198.5	753.5	206.2	711.7	224.3	685.7	235.4
720	5	767.1	177.6	744.1	189.9	717.3	204.2	690.5	218.7	676.9	227.9	636.8	247.1	611.2	259.2
	6	790.8	180.9	767.3	193.6	739.5	207.8	711.8	222.1	697.9	230.8	657.0	250.3	630.8	262.6
	7	815.4	184.8	791.4	197.4	763.2	211.5	735.1	225.6	720.0	234.0	678.5	253.9	650.9	266.3
	8	840.0	188.6	815.5	201.1	787.0	215.1	758.4	229.1	744.1	237.6	699.9	257.5	671.1	269.9
	9	864.6	192.4	839.6	204.9	810.7	218.7	781.8	232.6	767.3	241.0	721.3	261.2	691.2	273.5
	10	887.3	195.2	863.7	208.6	834.4	222.3	805.1	236.1	787.8	243.7	742.8	264.8	709.9	276.7
	11	913.7	200.1	887.8	212.4	858.1	226.0	828.5	239.6	813.5	247.8	764.2	268.4	731.4	280.8
	12	938.3	203.9	911.9	216.1	881.8	229.6	851.8	243.1	836.6	251.3	785.7	272.1	751.5	284.5
	13	962.9	207.7	936.0	219.9	905.6	233.2	875.1	246.6	859.7	254.7	807.1	275.7	772.5	288.4
	14	987.5	211.6	960.1	223.6	929.3	236.8	898.5	250.1	882.8	258.1	828.5	279.4	751.7	268.9
	15	1013.0	215.9	985.2	227.3	954.5	240.5	923.8	253.7	907.4	261.9	851.2	283.4	773.6	272.9

Note: The inlet/outlet water temperature difference is 5°C.

Model	Outlet Temp.	Ambient temperature													
		15		20		25		30		35		40		43	
		Cooling Capacity /kW	Power Input /kW	Cooling Capacity /kW	Power Input /kW	Cooling Capacity /kW	Power Input /kW	Cooling Capacity /kW	Power Input /kW	Cooling Capacity /kW	Power Input /kW	Cooling Capacity /kW	Power Input /kW	Cooling Capacity /kW	Power Input /kW
900	5	900.8	222.9	886.6	235.5	864.6	249.9	842.4	267.1	820.0	277.7	778.6	300.7	743.9	314.9
	6	936.7	225.7	921.0	236.9	900.8	252.9	878.5	270.2	854.0	281.2	808.0	304.7	771.9	318.8
	7	976.6	227.8	959.6	239.5	938.2	256.0	914.6	273.6	902.0	285.0	837.3	308.8	800.0	323.0
	8	1016.5	229.8	998.2	242.2	975.6	259.1	950.6	277.0	921.9	289.1	866.7	313.0	828.1	327.2
	9	1056.4	231.9	1036.8	244.8	1013.1	262.2	986.7	280.5	955.8	293.1	896.0	317.1	856.1	331.4
	10	1096.3	234.6	1075.4	247.5	1050.5	265.2	1022.8	283.9	989.8	297.1	925.4	321.2	884.2	335.6
	11	1136.2	237.2	1114.0	250.2	1087.9	268.3	1058.9	287.3	1023.8	301.0	954.8	325.3	912.3	339.8
	12	1176.1	239.5	1152.6	252.8	1125.4	271.4	1095.0	290.7	1057.7	305.0	984.1	329.4	940.3	344.0
	13	1216.0	241.7	1191.2	255.5	1162.8	274.4	1131.0	294.1	1091.7	308.9	1013.5	333.6	968.4	348.2
	14	1255.9	243.6	1229.8	258.1	1200.2	277.5	1167.1	297.6	1125.6	312.9	1042.8	337.7	996.5	352.4
15	1295.8	246.2	1268.4	262.1	1237.7	280.6	1203.2	301.3	1159.6	317.2	1072.2	341.9	1024.6	357.0	
1000	5	1047.0	244.0	1002.7	264.9	975.8	280.5	940.2	298.8	929.6	309.6	869.0	335.4	831.3	351.3
	6	1107.1	246.2	1058.0	267.4	1024.5	283.6	983.2	302.4	961.8	313.7	900.6	339.9	861.2	355.8
	7	1156.0	248.3	1104.1	269.9	1067.2	286.8	1022.8	306.1	996.0	318.0	934.0	344.6	893.4	360.7
	8	1204.9	250.3	1150.3	272.4	1110.0	290.0	1062.5	309.8	1033.4	322.8	967.5	349.4	925.5	365.5
	9	1253.8	252.4	1196.4	274.9	1152.7	293.1	1102.1	313.5	1069.2	327.3	1001.0	354.2	957.7	370.4
	10	1302.8	254.5	1260.9	277.5	1195.5	296.3	1141.8	317.2	1105.0	331.9	1034.4	358.9	985.3	374.5
	11	1351.7	256.6	1288.6	280.0	1238.2	299.5	1181.4	320.9	1140.9	336.4	1067.9	363.7	1022.0	380.2
	12	1400.6	258.7	1334.8	282.5	1280.9	302.6	1221.1	324.6	1176.7	341.0	1101.4	368.4	1054.1	385.0
	13	1449.6	260.8	1380.9	285.0	1323.7	305.8	1260.7	328.3	1212.5	345.5	1134.8	373.2	1086.3	389.9
	14	1498.5	262.9	1427.0	287.5	1366.4	308.9	1300.4	331.9	1248.3	350.1	1168.3	378.0	1118.4	394.8
15	1536.3	264.9	1464.0	290.1	1403.2	312.1	1336.7	335.8	1286.7	355.0	1203.6	383.0	1152.8	400.1	

Note: The inlet/outlet water temperature difference is 5°C.

Model	Outlet Temp.	Ambient temperature													
		15		20		25		30		35		40		43	
		Cooling Capacity /kW	Power Input /kW	Cooling Capacity /kW	Power Input /kW	Cooling Capacity /kW	Power Input /kW	Cooling Capacity /kW	Power Input /kW	Cooling Capacity /kW	Power Input /kW	Cooling Capacity /kW	Power Input /kW	Cooling Capacity /kW	Power Input /kW
1200	5	1316.6	271.8	1260.9	299.9	1216.0	323.3	1165.7	350.3	1131.1	370.7	1065.1	402.6	1024.8	422.0
	6	1367.3	274.4	1308.5	303.0	1259.8	327.2	1206.0	354.6	1166.1	375.7	1098.5	408.1	1056.8	427.7
	7	1417.8	276.9	1356.1	306.1	1304.3	331.0	1247.5	359.1	1203.0	381.0	1134.0	413.9	1090.7	433.7
	8	1468.3	279.4	1403.7	309.2	1348.8	334.9	1289.0	363.6	1242.7	386.8	1169.5	419.7	1124.5	439.7
	9	1518.8	282.0	1451.3	312.3	1393.3	338.7	1330.5	368.1	1281.0	392.3	1205.0	425.6	1158.4	445.8
	10	1569.3	284.5	1498.9	315.4	1437.8	342.6	1372.0	372.7	1315.1	397.1	1240.5	431.4	1188.5	451.1
	11	1619.8	287.0	1546.5	318.4	1482.3	346.5	1413.5	377.2	1357.6	403.3	1276.0	437.3	1226.2	457.8
	12	1670.3	289.6	1594.1	321.5	1526.8	350.3	1455.0	381.7	1395.8	408.9	1311.5	443.1	1260.0	463.8
	13	1720.8	292.1	1641.7	324.6	1571.3	354.2	1496.5	386.2	1434.1	414.4	1347.0	449.0	1293.9	469.9
	14	1771.3	294.7	1689.3	327.7	1615.8	358.0	1538.0	390.8	1472.4	419.9	1382.5	454.8	1327.8	475.9
	15	1821.6	297.1	1736.9	330.8	1661.0	361.9	1580.7	395.5	1513.1	425.8	1420.0	461.0	1363.6	482.3
1420	5	1516.8	353.6	1469.6	378.0	1416.0	406.7	1362.3	435.6	1331.3	453.7	1255.0	492.3	1206.7	516.6
	6	1562.6	360.0	1515.5	385.4	1460.4	413.8	1405.3	442.3	1375.8	459.7	1296.5	498.7	1245.4	523.4
	7	1610.9	367.5	1563.1	392.7	1507.4	421.0	1451.6	449.2	1419.0	466.0	1339.2	505.9	1285.2	530.6
	8	1659.2	375.0	1610.7	400.1	1554.3	428.1	1497.9	456.1	1468.8	473.3	1381.8	513.1	1325.0	537.8
	9	1707.6	382.5	1658.3	407.5	1601.3	435.3	1544.2	463.0	1515.3	480.2	1424.4	520.3	1364.7	545.0
	10	1755.9	390.0	1705.9	414.9	1648.2	442.4	1590.5	469.9	1561.8	487.0	1467.1	527.5	1404.5	552.1
	11	1804.2	397.5	1753.5	422.2	1695.2	449.6	1636.7	476.9	1608.3	493.8	1509.7	534.7	1444.2	559.3
	12	1852.6	405.0	1801.1	429.6	1742.1	456.7	1683.0	483.8	1654.8	500.7	1552.3	541.9	1484.0	566.5
	13	1900.9	412.5	1848.7	437.0	1789.1	463.8	1729.3	490.7	1701.3	507.5	1595.0	549.1	1525.4	574.3
	14	1949.2	420.0	1896.3	444.3	1836.0	471.0	1775.6	497.6	1747.8	514.3	1637.6	556.3	1491.7	535.5
	15	2000.1	428.5	1945.7	451.7	1885.5	478.1	1825.3	504.8	1794.5	521.6	1681.4	564.3	1538.1	543.9



Note: The inlet/outlet water temperature difference is 5°C.

## 9. Accessories

### Standard accessories

NO.	Name	Quantity
1	Qualified certification	1
2	User manual	1
3	Water flow switch connectors	1
4	Packing list	1

### Optional accessories

No.	Name	Model	Introduction	Picture
1	Water flow switch	WFS-1001-H (Honeywell)	Installed on evaporator outlet pipe to prevent heat exchange pipe from frost crack.	
2	Vibration damper	MHD Series	To avoid vibration and noise, it must be used between base and foundation when install the unit.	
3	Remote control cabinet	YCKZ-P	Can be installed in the control room. Through the cable connected to the unit touch screen, it can display all states information and complete all the operations of unit (startup/shutdown, error confirm, etc.)	

### III. Controls

#### 1. Control flow chart

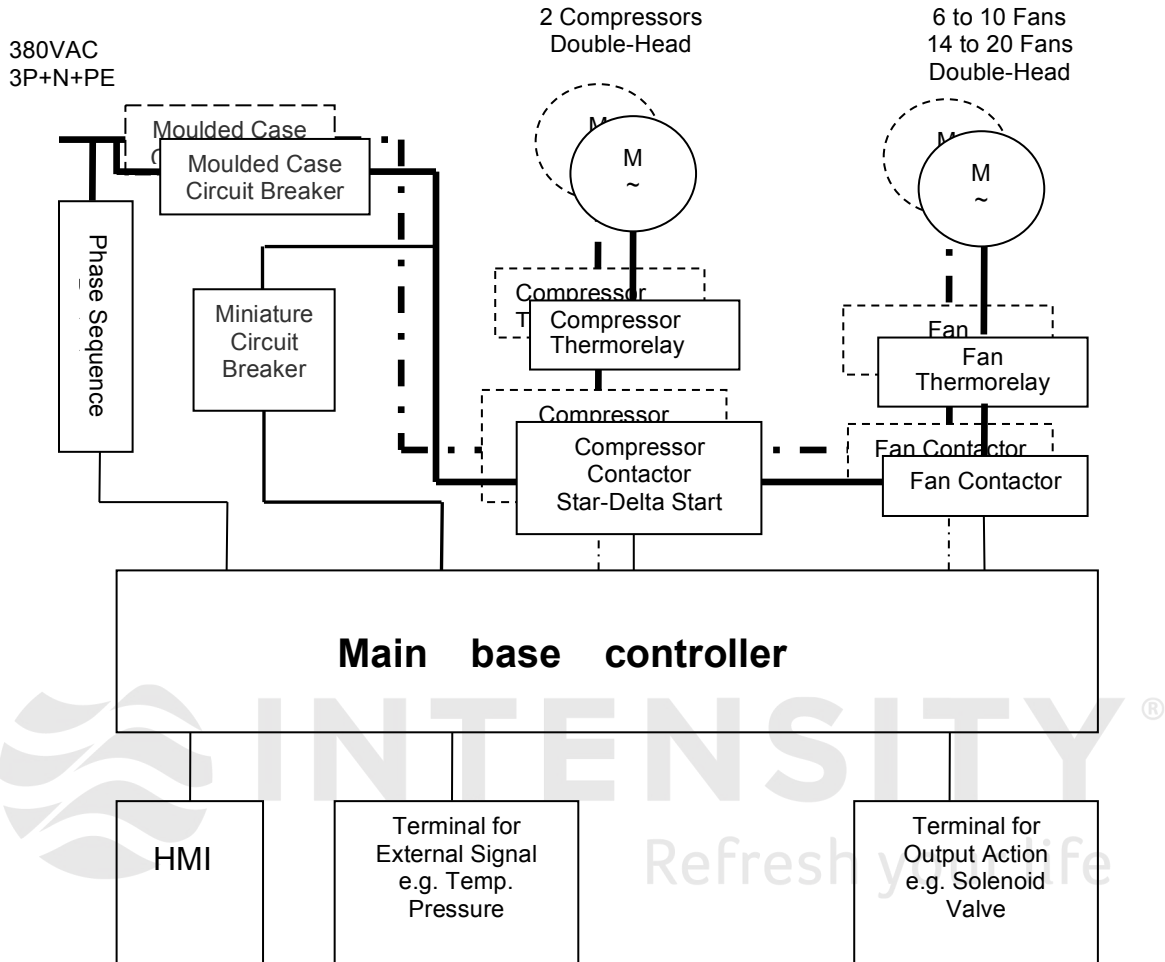

Main base controller gathers signals through input terminals, such as pressure, temperature and the state of protection switches and ensures unit's current condition. At the same time, according to input signal from HMI, such as starting signal, controller performs the logical operations and outputs signals. These signals act on components, time relay, contactors and so on.

#### HMI+ Main base controller:

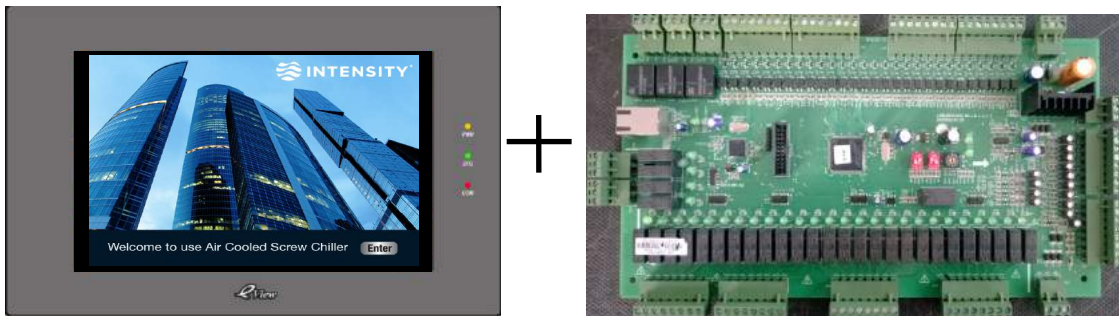

## 2. Energy adjustment

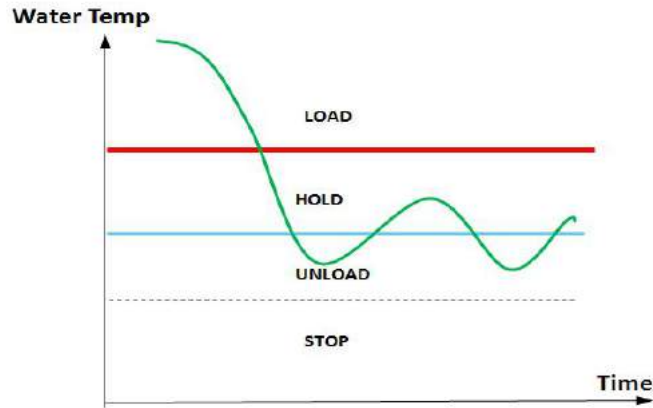

The unit can adjust capacity by chilled water, please see above picture.

**Energy adjustment is restricted when starting high pressure is too high.**

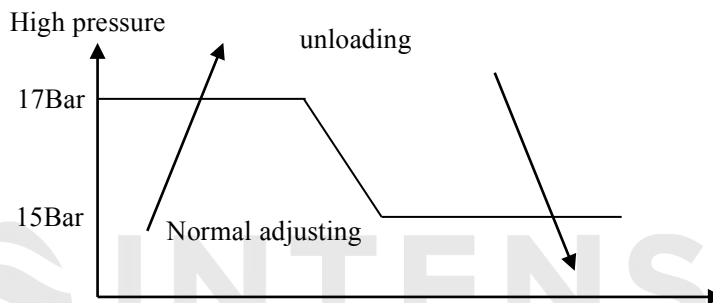

## 3. Start/stop process



INTENSITY®

Refresh your life



# 1).Cooling start

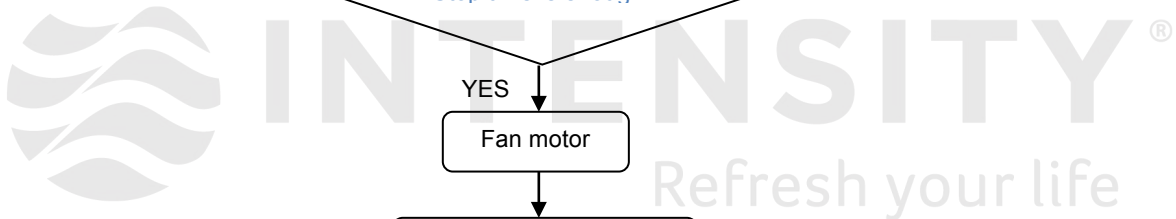
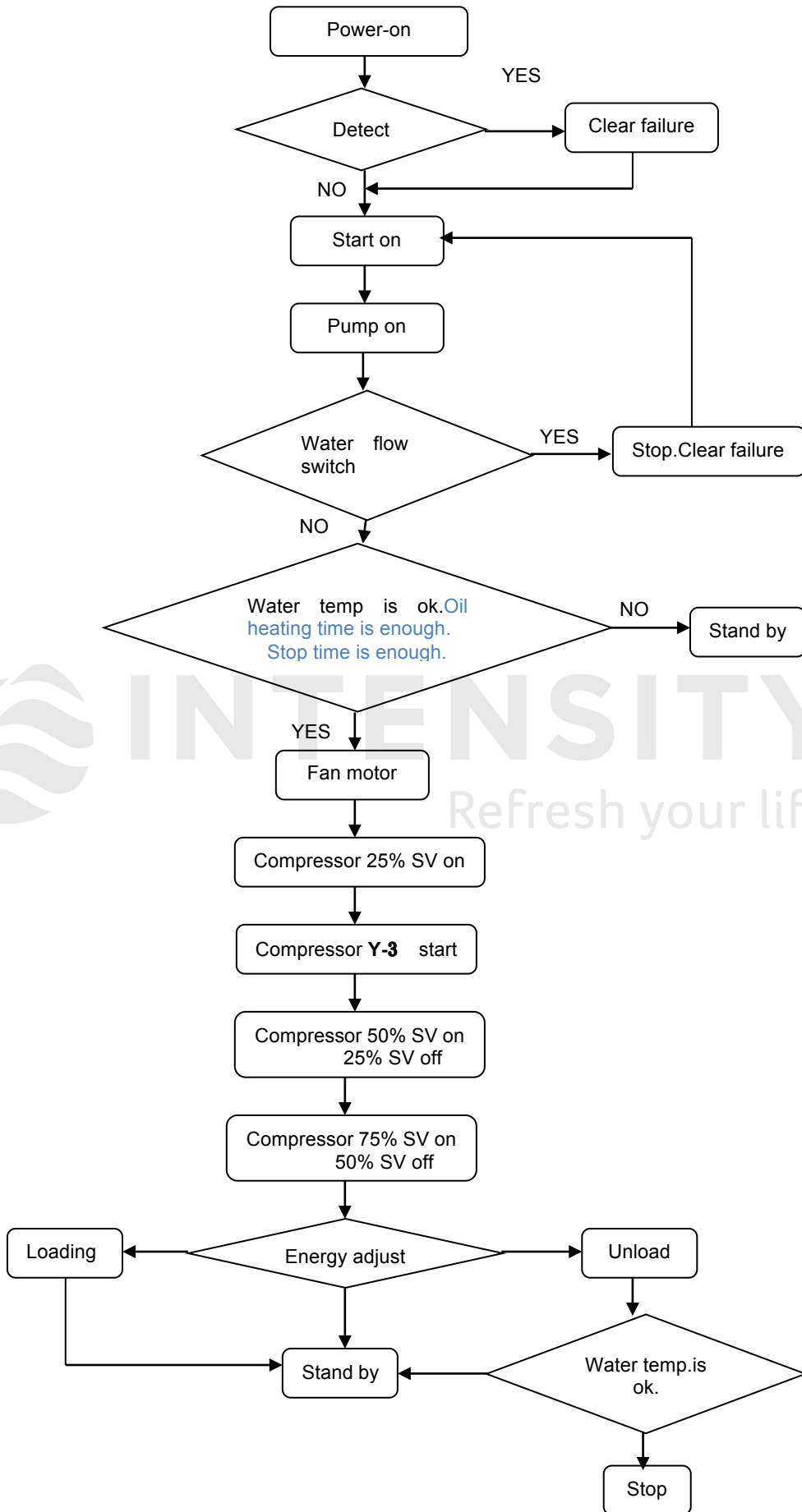

## 2).Cooling stop

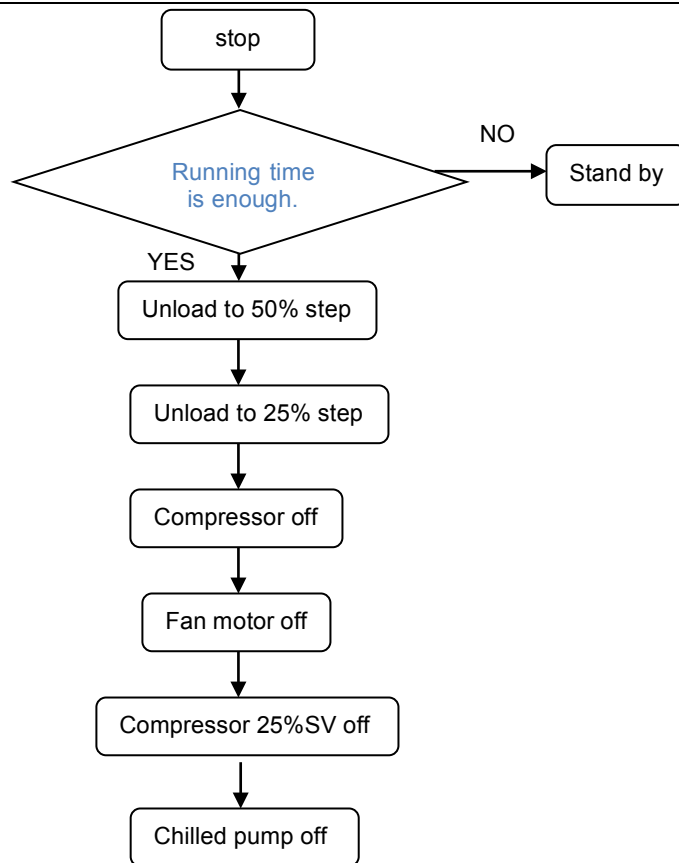

**INTENSITY**<sup>®</sup>  
Refresh your life

## 4. Sensors

### 1). Temperature sensors

The temp. sensors use NTC thermistors, they including chilled leaving water temp., chilled entering water temp., ambient temp., condenser fin temp., discharge temp., EXV suction temp..

NO.	Name	Type	Remark
1	Chilled entering water temp.	NTC,10k@25°C	Emerson
2	Chilled leaving water temp.	NTC,10k@25°C	Emerson
3	Ambient temp.	NTC,10k@25°C	
4	Discharge temp.	NTC,5k@90°C	CGQ-PQI
5	EXV suction temp.	NTC,10k@25°C	Carel

### 2). Pressure sensors

The pressure sensors are **pressure transmitters**, including high pressure, low pressure, EXV suction pressure transmitters. **Danfoss AKS3000** are used.



Water temp. thermistor



Ambient or pipe temp. thermistor



Pressure transmitter AK3000

## 5. Parts control

### 1). Oil heater control

In unit sand by period, oil heater is energized to keep normal oil temperature. When unit starts, it is turned off.

Oil heating time limits:

- When cooling water inlet temperature  $\geq 35^{\circ}\text{C}$  (real time value), oil heating time for first startup is 0.5h. If power down happens during operation and downtime is less than 8hrs, no heating time delay is needed when unit restarts. If it exceeds 8hrs, 0.5h heating time is need.
- When cooling water inlet temperature  $\geq 30^{\circ}\text{C}$  (real time value), oil heating time for first startup is 1h. If power down happens during operation and downtime is less than 5hrs, no heating time delay is needed when unit restarts. If it exceeds 5hrs, 1h heating time is need.
- When cooling water inlet temperature  $\geq 25^{\circ}\text{C}$  (real time value), oil heating time for first startup is 2hrs. If power down happens during operation and downtime is less than 3hrs, no heating time delay is needed when unit restarts. If it exceeds 3hrs, 0.5h heating time is need. If it exceeds 5hrs, 2hrs heating time is need.

## 2). Fan Control

The number of operating fan as required is according to the discharge pressure. For example, for LSBLGW500/C, there are 8 fans, divided into 5 groups. Opening condition as follow:

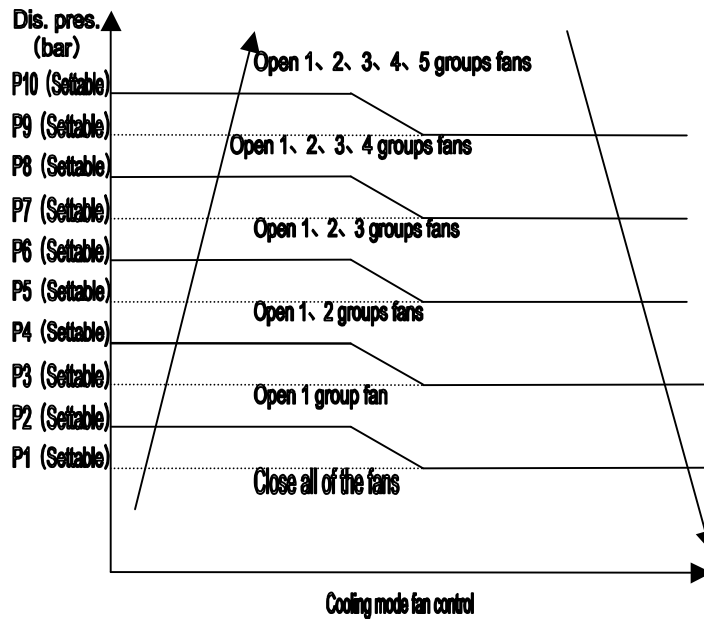

## 3). Solenoid valve control

### a. Compressor suction injection solenoid valve control

Compressor suction injection solenoid valve control is opened when running discharge temperature is higher than setting value (default 100°C). It is closed when discharge temperature is lower than setting value (default 90°C).

### b. Compressor central injection solenoid valve control

Compressor central injection solenoid valve control is opened when running discharge temperature is higher than setting value (default 85°C). It is closed when discharge temperature is lower than setting value (default 75°C).

### c. Economizer solenoid valve control

Economizer solenoid valve is opened after unit started.

## 4). Pressure sensor control

### a. High pressure control

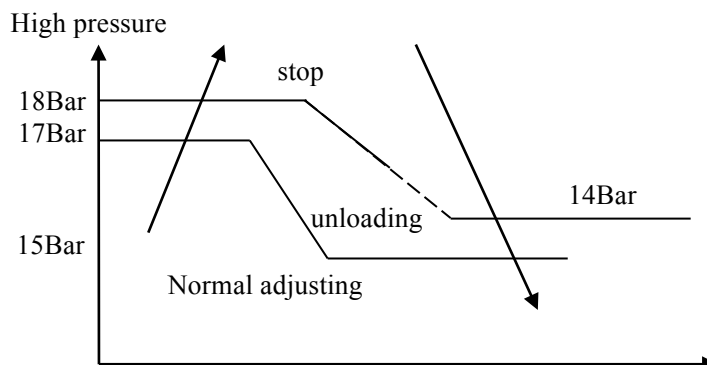

**b. Low pressure control**

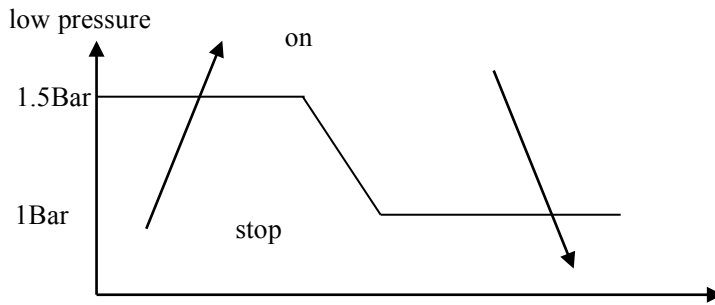

**5). EXV controller control**

**a. EXV controller wiring principle**

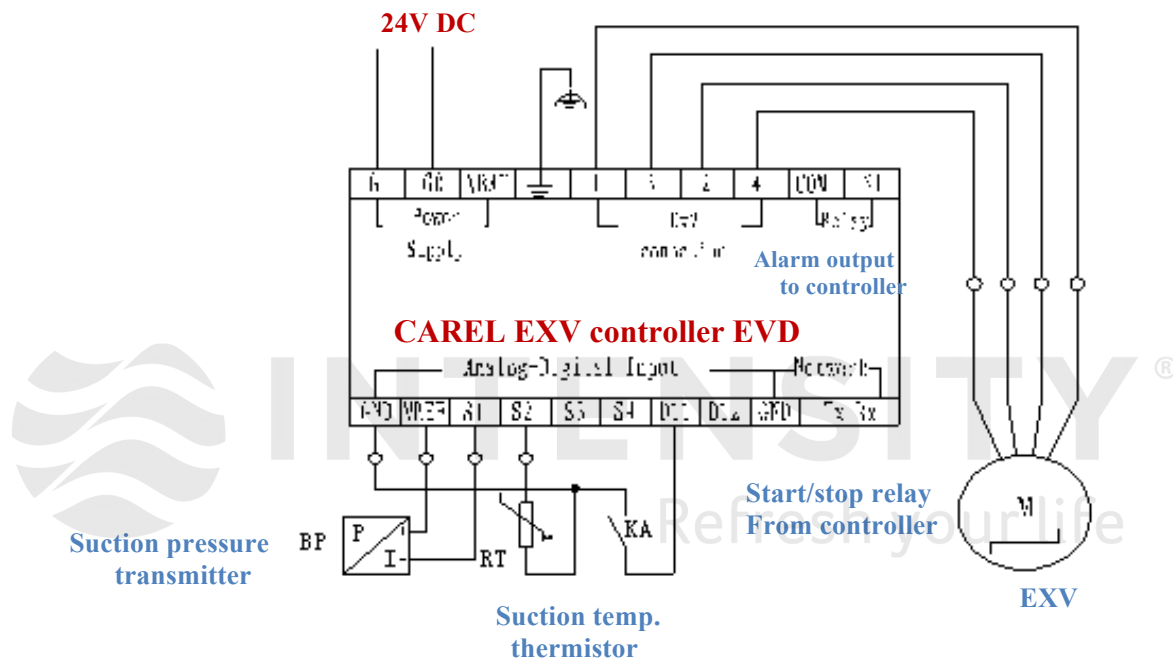

EXV controller is started by main base controller. it detects suction pressure and suction temperature and calculate suction superheat. Then it control EXV opening depending on super heat. If it is wrong, EXV will output alarm signal to main base controller.

**b. Controller display**

The interface of EXV controller can not display and set parameter on unit, it only displays running status.



LED	Light	Extinguish	Flicker
NET	Can be connected to the network	Not connected	Communication failure
OPEN	Open the valve	-	Disable the drive
CLOSE	Close the valve	-	Disable the drive
	Activate the alarm	-	-
	Drive power	The drive is not connected to power supply	-

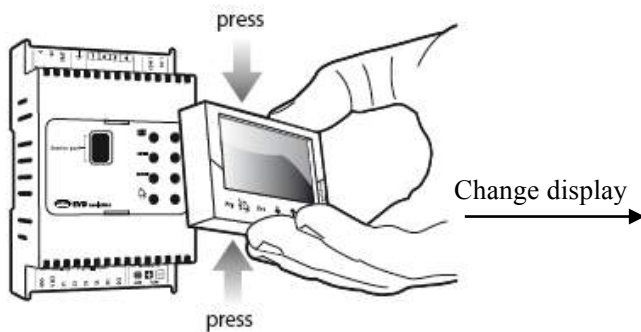
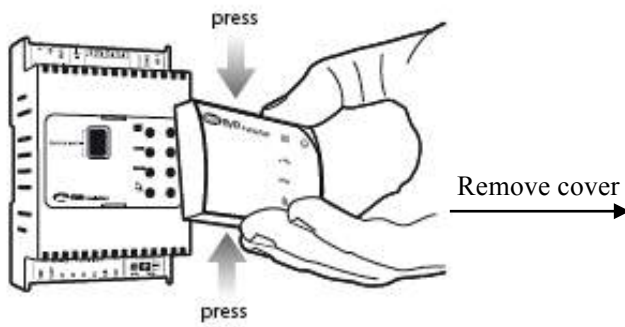

If parameters need to be displayed and set, the interface should be changed.

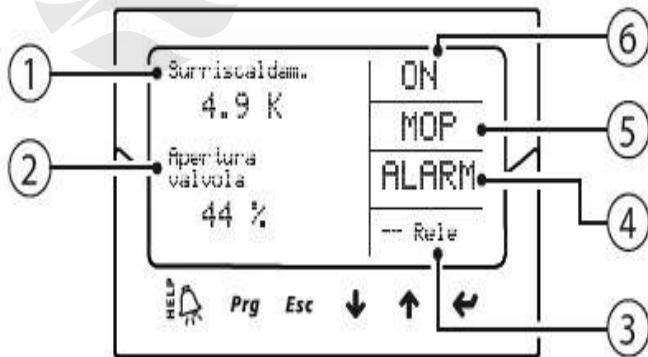

## Display

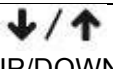

1	Display suction superheat
2	Display EXV opening
3	Relay output status
4	Alarm
5	Start of the protection
6	Control state

Button	Function
Prg	Open the display screen, enter the password to enter the programming mode
	<ul style="list-style-type: none"> <li>In the alarm state, the display alerts the queue;</li> <li>When the "producer" level under the rolling parameters, the display shows the interface</li> </ul>
Esc	<ul style="list-style-type: none"> <li>To exit the programming (maintenance / producer) and display mode;</li> <li>set a parameter, the exit without saving changes</li> </ul>
 UP/DOWN	<ul style="list-style-type: none"> <li>Display screen navigation;</li> <li>Increase / decrease the value</li> </ul>
 Enter	<ul style="list-style-type: none"> <li>from the parameter setting mode, the display switches to</li> <li>Confirm the list of parameters and return the value</li> </ul>

### Running status



### Display all status



Press ↓/↑  
←  
Press Esc button

### b. Controller parameter checking and changing.

#### Checking or changing repair parameters step:

- ① Press one or more Esc to switch to the standard display interface;
- ② Press Prg: display interface input password;
- ③ Press ENTER input repair level password: 22, starting from the rightmost digit, each input a digital, confirm with ENTER ;

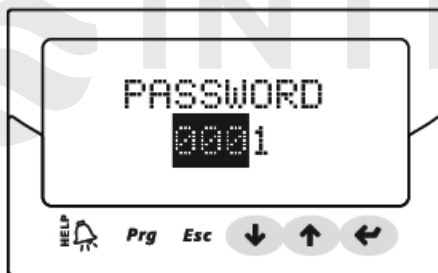

- ④ If the password is correct, will display the first parameters can be modified: network address;
  - ⑤ Press UP/DOWN to select parameters should be set up;
  - ⑥ Press ENTER to move to the parameter value;
  - ⑦ Press UP/DOWN to modify the parameter value;
  - ⑧ Press ENTER to save the new parameter values;
- 1 Repeat the above 5, 6, 7, 8 step change other parameters;
  - 2 Press Esc to exit the repair parameters modify the program.

The following shows the detailed settings: 13 pages

Drive hardware configuration	1/13
Network address 198	

Drive hardware configuration	2/13
Refrigerant type	R134a
Valve type	Danfoss ETS 250

Drive hardware configuration	3/13
Type of probe S1	User-defined
Unit type	Fin coil evaporator air-conditioner

Drive hardware configuration	4/13
Type of probe S1	NTC Carel
Auxiliary control type	Disabled

Drive hardware configuration	5/13
Type of probe S3	Unused
Relay configuration	Generate alarms

Drive hardware configuration	6/13
Type of probe S4	Unused
DI1 configuration	Start/stop SH control

Drive hardware configuration	7/13
Language	Chinese
DI2 configuration	Disabled

Control parameter settings	8/13
Overheat degree	6.0K
Valve opening upon start	50%
Pre-positioning duration	30s

Control parameter settings	9/13
Hot air by-pass temperature	---
Hot air by-pass temperature	---
EPR back pressure	---

Control parameter settings	10/13
LowSH	2.0K
LOP	-50°C
MOP	50°C

Control parameter settings	11/13
Enable manual valve positioning	0
Manually set the valve position 0stp	

Control parameter settings	12/13
HiTcond threshold	80.0°C
Constant temperature adjustment point	0°C
Constant temperature adjustment variance	0.1K

Control parameter settings	13/13
DC power supply mode	1



**Checking or changing manufacturer parameters step:**

- ① Press one or more Esc to switch to the standard display interface;
- ② Press Prg: display interface input password;
- ③ Press ENTER input manufacturer password, starting from the right most digit, each input a digital, confirm with ENTER ;
- ④ If the password is correct, it will display the following parameter type list:

- Configuration parameters
- Sensor parameters
- Control parameters
- The special parameters
- Alert configuration parameters
- Valve parameters



- ⑤ Press UP/DOWN button to select the category, and then press ENTER to enter the first class number
- ⑥ Press UP/DOWN to select parameters to be set, and then press ENTER to move to the parameter value;
- ⑦ Press UP/DOWN to modify the parameter value;
- ⑧ Press ENTER to save the new parameter values;
- ⑨ Repeat the above 6, 7, 8 step change other parameters;
- ⑩ Press "Esc" to exit the manufacturer parameter modification program.

Unit Type		380,500,600,720,900,1000,1200,1420	Remarks
Setting parameters	Refrigerant	R134a	Selected based on the refrigerant type of the unit
	Valve	Danfoss ETS250	
	Sensor S1	4-20 mA; 0-10.0 V	Automatically brought out by subsequently set parameters
	Control mode	shell-and-tube unit	
	Overheat degree	6	
	Valve opening upon start	50%	
	Pre-positioning delay	6	
	Valve opening in standby state	0	
	Power supply mode	1	Available values include: (1) 0: 24 V AC (2) 1: 24 V DC; default value:
Check parameters	Enable manual valve positioning	0	
	Manually set the valve position	0	
	Auxiliary control	Invalid	

Relay settings	Alarm relay	
DI2 settings	Invalid	
Variable 1 on the display	Overheat degree	
Variable 2 on the display	Valve opened	
Sensor S1 alarm management	Valve at a fixed position	
Sensor S2 alarm management	Valve at a fixed position	
S1: calibration offset	0	
S1: calibration gain, 4–20 mA	1	
Pressure sensor S1: minimum value	0	Set based on the actual sensor
Pressure sensor S1: maximum value	30	Set based on the actual sensor
Pressure sensor S1: minimum value for alarms	0	Set based on the actual sensor
Pressure sensor S1: maximum value for alarms	30	Set based on the actual sensor
Sensor S2	CAREL NTC	
Language	English	
Measurement unit	°C (K), bar g	
PID: proportional gain	80	
PID: integration time	40	
PID: derivation time	1.5	
Minimum number of valve steps	350	
Maximum number of valve steps	3810	
Number of steps for valve closing	3970	
Valve rate	250	
Low SH protection: threshold	1	
Low SH protection: integration time	2.5	
LOP protection: threshold	-50	
LOP protection: integration time	4	
MOP protection: threshold	50	
MOP protection: integration time	10	
Low overheat degree alarm delay (Low SH, 0 = no alarm)	300	
Low evaporation temperature alarm delay (LOP, 0 = no alarm)	300	
High evaporation temperature alarm delay (MOP, 0 = no alarm)	600	
Low air suction temperature alarm threshold	-50	
Low air suction temperature alarm delay (0 = no alarm)	300	

## 6. HMI operation

### 1) Initial Startup

- Before power up for the first time, make sure that the wiring is firm between the control box and the main switch, the insulation resistances reach the requirements, and the earth wire has been properly installed.
- The wiring might be loose due to the factors such as long-distance transport. Carry out complete inspection for the bolts of all wiring terminals for looseness.
- Be sure that the distribution capacity is compliant with the power of the unit and the diameter of the selected cable can bear the maximum working current of the unit.
- Inspect whether the red emergency stop button on the control box is in natural state.

## 1) Introduction of Control Screen:

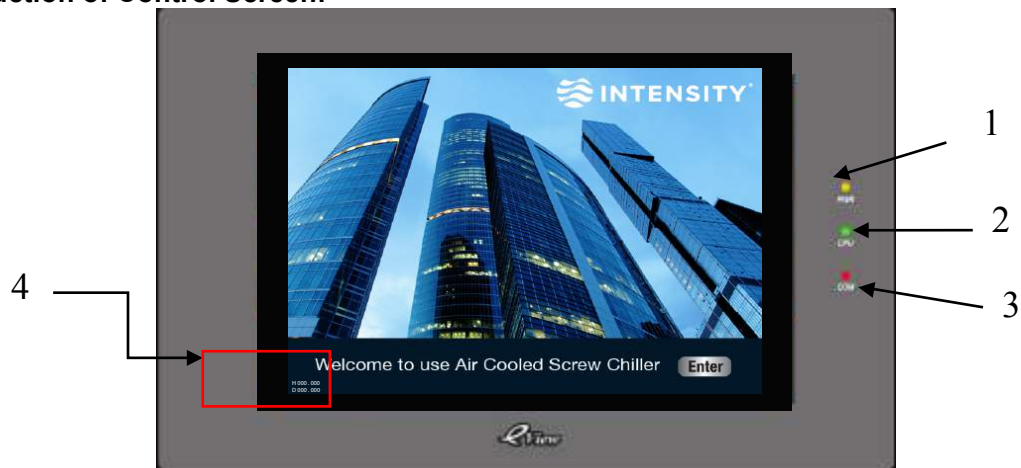

(Home page)

- 1) Power indicator (yellow), which is on when display is powered on; it is off when powered off.
- 2) Status indicator (green), which flashes at low frequency when display is normally operative, otherwise it is off.
- 3) Communication indicator (red), which flashes at high frequency when display and controller communicate normally, otherwise it is off.
- 4) Controller and touch screen procedure version: showing the number of controller and touch screen procedure version used by the current unit.

## Basic Interface and Operations:

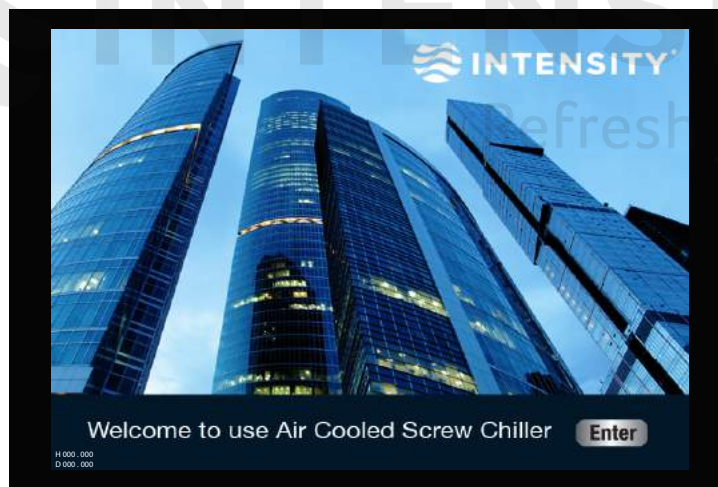

After the system initializing is completed, please click on **Enter** button, and the “Password Input” dialog will be popped up, please input the User Password (58806) or User Manage Password (40828), and click “ENTER” into the next interface (Mode Setting Page).



❖ **Mode setting page**

Password input page

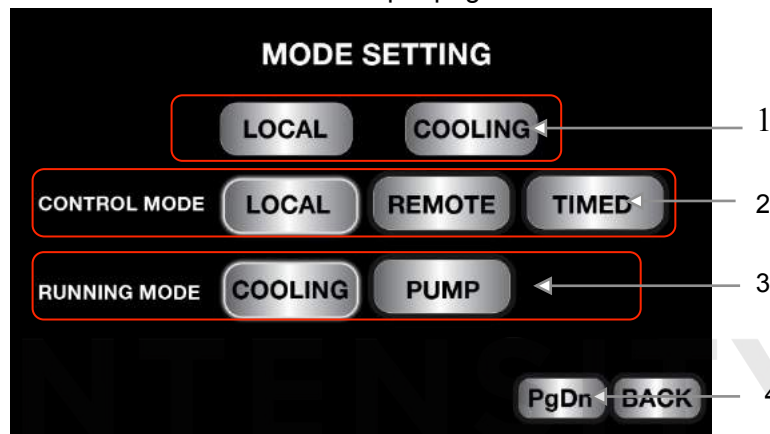

(Mode setting page)

Control mode and working mode are to be set in this page:

1. Control mode and running mode which have been selected currently for units are displayed here, and this position will correspondingly vary according to the choices of customers when selection of modes is changed.
2. Selection of unit control modes, including three modes: “LOCAL”, “REMOTE”, “TIMED”, i.e. local control, remote control, timing control.
3. Selection of unit operation modes, including three modes: “PUMP”, “COOLING”, i.e. pump mode, cooling mode.
4. Click on “PgDn” to enter the next page (Main Page).
5. Click on “BACK”, return to the homepage of units.

Note:

- ⊖ The control mode and running mode can be selected optionally in standby status, while only the control mode can be switched in running status.
- ⊖ Control Mode: The selection of the ways of Unit starting/stopping. “LOCAL” indicates you can only start or stop the unit through “Start/Stop” button in touch screen. “REMOTE” indicates you can only achieve the unit starting or stopping though the “Remote Start” and “Remote Stop” hardware interfaces; “TIMED” indicates the unit can achieve timing start/stop according to the time set by the user.

◇ Main Page

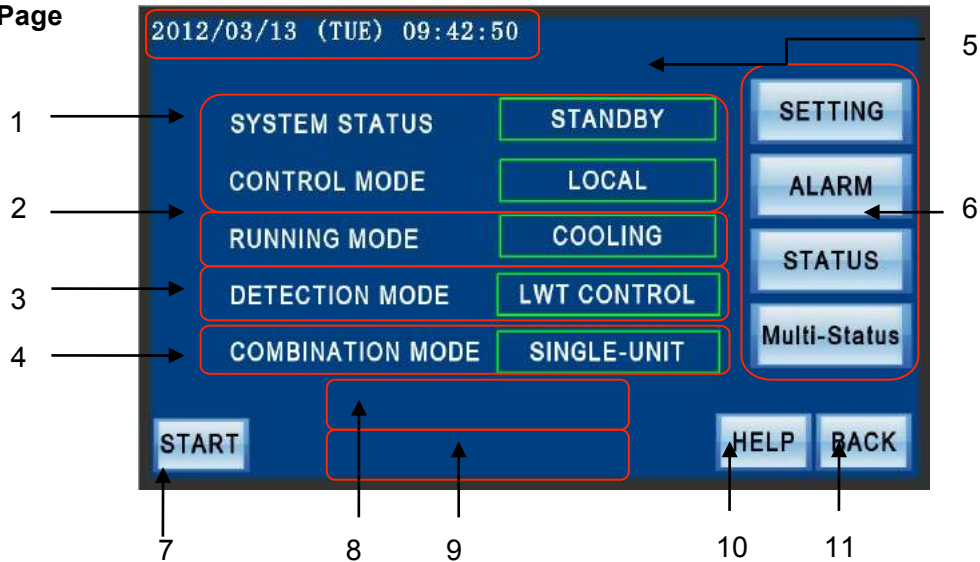

(Main page)

1. System Status: Current system status of units is displayed here. The status of system possibly displayed is as follows:
  - 1) Standby status: in normal condition, displaying “Standby status” after the unit is powered on.
  - 2) Running status: indicating that starting of unit compressors has been finished (entering the running status after double-head Start of one compressor), and it has entered the process of automatic energy adjustment from this point.
  - 3) Pause status: The unit enters “Pause” status when the current detection water temperature (chilled outlet water temperature in single-unit or chilled inlet water temperature in Multi-units) is lower than the setting temperature of unit pause. The compressor start to run until the current detection temperature is higher than the setting temperature of compressor start, then the unit enter “Running” status.
  - 4) Shutting down status: the status display “shutting down” after the unit has been confirmed to execute shutdown action. After finished, the unit enters “Standby” Status.
  - 5) Protection status: indicating that the unit is in a failure status currently, click on "alarm information" to see alarm details.
2. Control mode and running mode: the current mode will be displayed here. For example, the current page displays that the unit is in a “LOCAL MODE”, and the running mode is “PUMP MODE”.
3. Detection Mode: Leaving water control is by default only in the single-unit mode, with entering water control not allowed; entering water control is by default in the multi-units combination mode, with setting of leaving water control not allowed°
4. Combination Mode: indicates “Single-unit” when the unit isn’t in the case of multi-combination control and indicates “Multi-Units” when the unit is in Multi-combination control. (Note: When the system has only one unit, please don’t set to multi-unit control)
5. This position is the unit alarm display area, and alarm information of failure content will be displayed here in a mobile mode in case of any failure in units.
6. Functional key area of units. It has the functional keys of “SETTING”, “ALARM”, “STATUS” and “Multi-Unit” through which different operating interfaces are accessible. Introduction of their functions will be detailed hereafter.

7. Start is required upon completion of unit set-up, directly click on “START” button on the lower left, and the following dialog box will be popped up at this moment: click on “CANCEL” if you don’t expect to execute the start.



【Ensure unit start-up】

8. The sign “Failure to start, please check the status” will appear when the conditions of compressor starting can’t be required.
9. There is a rotate button with a key beside the touch screen. When the units need to be maintained by the user or after sale service personnel while expecting to see parameters from the touch screen, the user may rotate the button to the service point, and “System under maintenance, please don’t start up!” will be displayed below main page at that moment. Start operation is not allowed at this moment. Any action of maintenance or power operation shall not be taken in the absence of personnel who have been specially trained and certified!
10. Help information, abbreviation of words in units will be explained in detail in help interface.
11. Click on “BACK”, return to previous page of units-----mode selection interface.

Note:



button disappear when the combination mode is “Single-unit”. Click



button to query the current unit status.

### Starting Operation

The system is in pause state when the water pump has been completed to open, but the compressor is unable to start because some other factors can’t satisfy the condition of compressor starting, the interface indicates “Failure to start, please check the status”. The starting conditions include oil heating time ´ restart delay´ the temperature of compressor starting. In this case, only when all of the conditions have been meet, the unit starts to operate the compressor, otherwise the sign “Failure to start, please check the status” will keep displaying in the main page.

Note: Clicking on  button is invalid when the unit is in failure. The unit can start normally only when all of the alarm have been eliminated and reset manually on the touch screen interface.



When the current ambient temperature is beyond the allowed running range, the below page will be popped up:

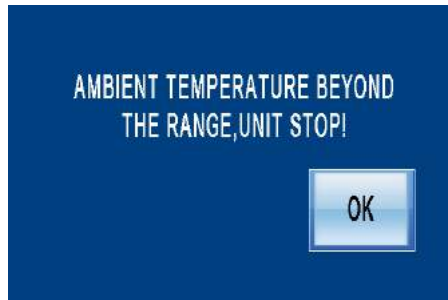

If the current temperature return to the rage, click to the“OK”and the unit will start to run normally.

### Shutting down operation

Click on **STOP** button , and the “Confirm Shutdown” dialog will be popped up. Click on “Confirm” if you ensure execution of Shutdown action, the system status indicates “Shutting down”. (Note: The system status indicates “shutting down” even the requirements of shutting down the compressor are not meet. The unit will execute shutdown action automatically after all of the requirements have been satisfied. )



The action of 4 functional keys in main page will be detailed in subsequent sections:

#### ✧ **Setting**

Click on **SETTING** in main page to enter the password page. Click on the dialog box of password input, an input keyboard will be popped up in the interface, input user manage password “40828”, then click on “Enter” in numeric keyboard, the dialog box disappears, click on “ENTER” to enter “User Parameter Setting Page”.



【 User parameter setting page 】



Password error page

“Password Error Page” will be popped up when the password is wrong, click on  button to return “Password Input Interface”, input the password again to enter the next page.

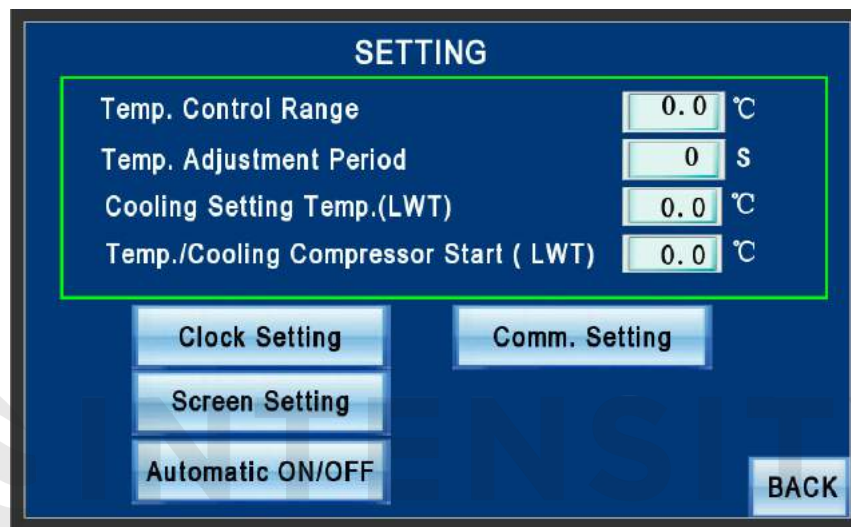

Note:

- ⊖ “Max” in the upper left indicates the upper limit of the setting parameter; “Min” in the upper right indicates the lower limit.
- ⊖ “Automatic On/Off”: Only displaying under Timed mode.

**Explanation:**

- ⊖ Target Temp. (Chilled Leaving Water): The target temperature of the chiller leaving water
- ⊖ Temp. / Compressor start (Chilled Leaving Water): One of the compressor starting conditions required to be achieved for the chilled leaving water temperature. The compressor can start only at the current chilled leaving water temperature > the setting value in cooling mode, or the current chilled leaving water temperature < the setting value in heating mode.
- ⊗ Temp. Adjustment Period: The time interval between two temperature detections.



✧ **Clock setting**



(Clock setting)

Click on the numerical box, the numeric keyboard will appear, input the time, click “ENT” to save and take effect. Click “ESC” to cancel the input value.

**Note:** Please pay special attention in setting of time and date to the fact that setting of non-existent date or time is not allowed, and we assume no liability or responsibility for setting of non-existent date or time and consequence resulting from this setting.

✧ **Adjust screen**

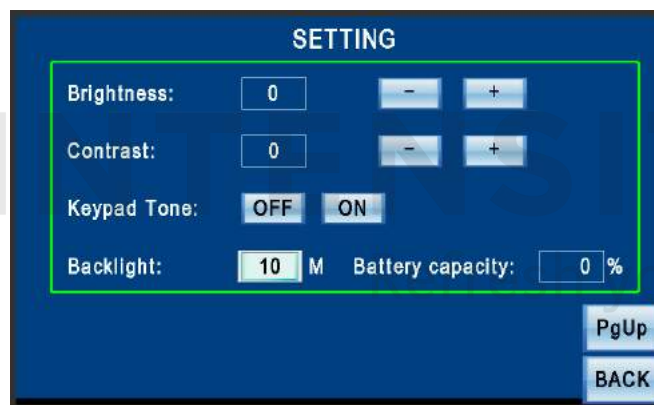

User can increase and reduce the brightness and contrast of screen by clicking on “+” and “-” in this page.

User can also open and close the keypad tone of screen by clicking on “ON” and “OFF”.

User can modify the time of backlight by clicking on the numeric box following the time of backlight.

Electric control capacity displays the battery capacity of PLC whose battery is used for supplying power for PLC interior time in the case of failure to engage PLC. Reset of PLC interior event will be resulted from too long power-fail time of PLC module without battery.

✧ **Automatic On/Off**

If the automatic on/off function is needed, please switch to “TIMED” mode in control mode (as shown in

Picture 2) firstly, then enter user parameters setting page, click on



button to enter the

following page ,and set the starting times and shutdown times.

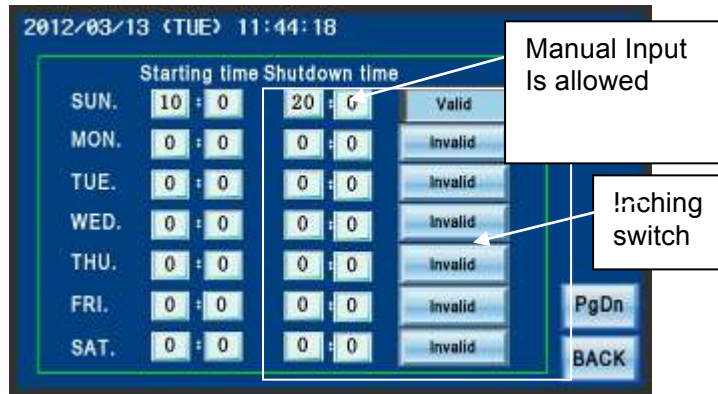

#### Automatic On/Off setting

Any time every day in a week can be selected, and the units will be started or stopped at the time points. When a period of continuous running time (for example from 10:00 Tuesday to 16:00 Thursday) is necessary, you can set the time 10:00 in starting time and 0:00 in shutdown time on Tuesday and click on “Invalid” to switch to “Valid”, set the time 0:00 in starting time and 16:00 in shutdown time on Thursday and click on “Invalid” to switch to “Valid”, all of the others time buttons are “Invalid”. Pay attention to that the starting time must be before the shutdown time.

Since system interior time is used for timing start / stop, please draw attention to check whether the time of the system is correct when you are using this function.

#### ✧ Comm. Setting

Click on “Comm. Setting” to enter the below page:

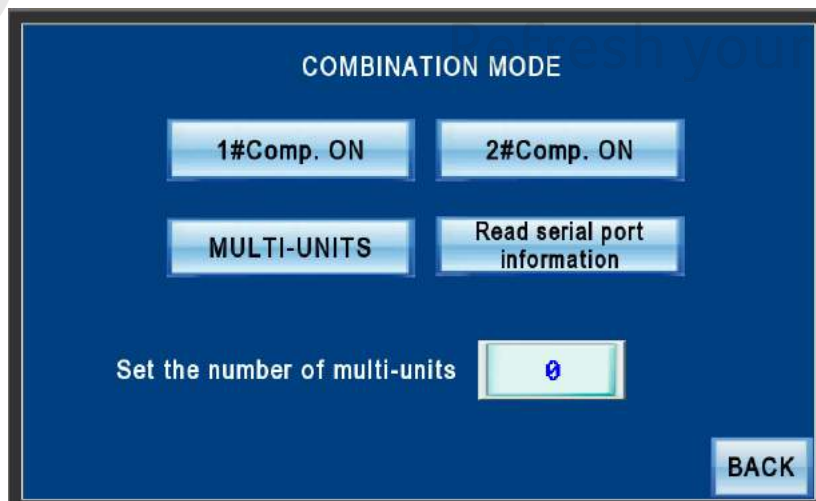

Note: “1#Comp. ON” “2#Comp. ON” only appear in dual-compressors units.

- ⊖ Multi-Units: When the unit need to be multiple controlled, please contact the after-sale service engineers to do settings of the unit. After setting well, press the “Single unit” button, it will turn to “Multi units”, then the number of multi units should be set according to the practical situation.
- ⊖ “1#comp. on” “2#comp. on”: No.1 or No.2 compressor can be selected to work or not, when the compressor meet the conditions it will shut down refer to the stop progress if user want to stop one compressor.

Click on **Read serial port information** to read serial port information when the unit need to be multiple controlled.

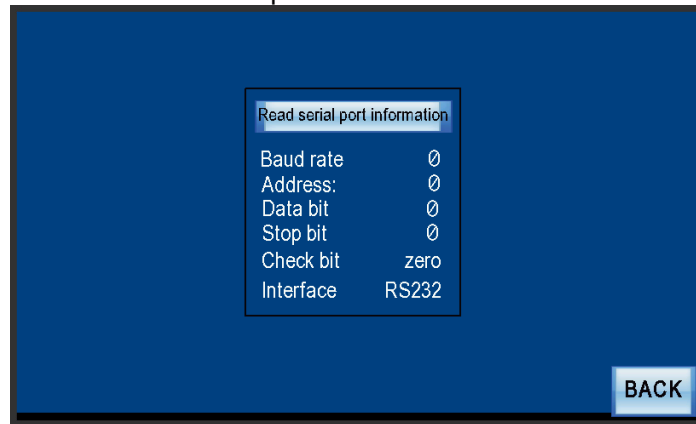

**Read serial port information**

✧ **Status**

Click on **STATUS** in main page to check the current unit status information.

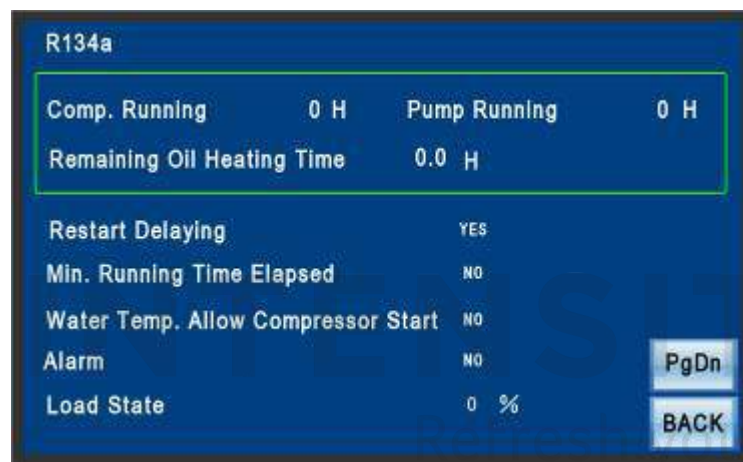

**Status information**

The upper left in the page display the refrigerant type; the upper right display the station number address, the station number of master is set to 1.

Note:

To start up, following conditions are required:

- ⊖ "Restart Delaying" need to display "NO" ,if "YES", it indicates the delaying period has not achieved.
- ⊖ "Water Temp. Allow Compressor Start" need to display "YES", if "NO", it indicates the current temperature is not able to meet the compressor starting condition.
- ⊗ "Remaining Oil Heating Time" need to display "0", if more than 0, it indicates the oil heating is in process.

To shut down, the following condition is required:

- ⊖ "Min. Running Time Elapsed" need to display "YES", if 'NO', it indicates the shortest running period has not achieved.

**Current data display**

Please click on **PgDn** button to enter the current data interface, the interface indicates current detection data. User can enter this interface to query the temperature information when there are alarms such as temperature too high or too low.

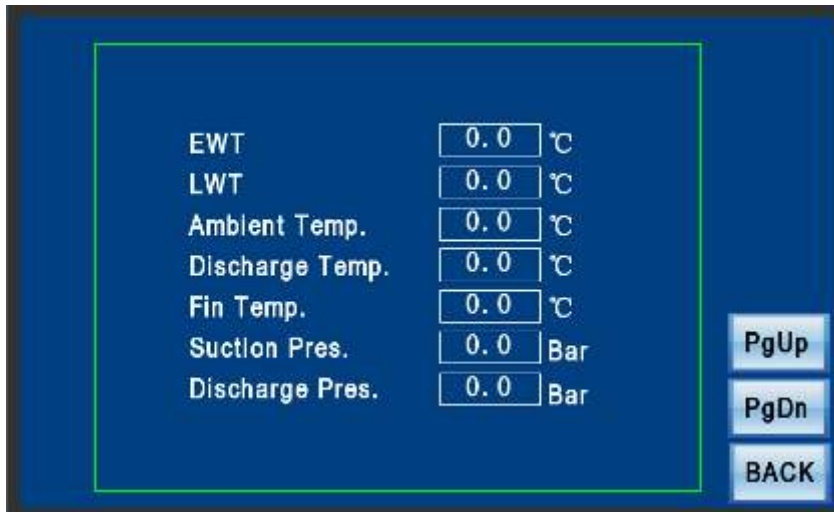

Current data display

**Input**

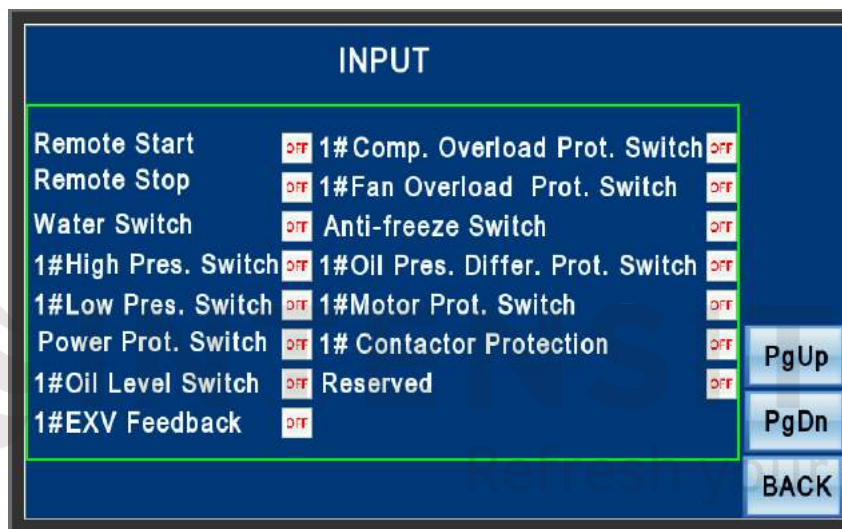

Input status

“ON” as displayed indicates the input point is closed; “OFF” as displayed indicates the input point is open.

Note:

- ⊖ “Remote Start/Stop” is available only under REMOTE mode.
- ⊖ “Water Switch”: indicating that current water flow status of chilled water system. “OFF” displayed in no water flow state, otherwise “ON”.
- ⊗ “Contactor Protection”: indicating that when the compressor start to run, the contactor act normally, “OFF” switch to “ON”.
- ④ All of protection switch is “ON” in normal condition and “OFF” in failure status.

✧ **Output status**

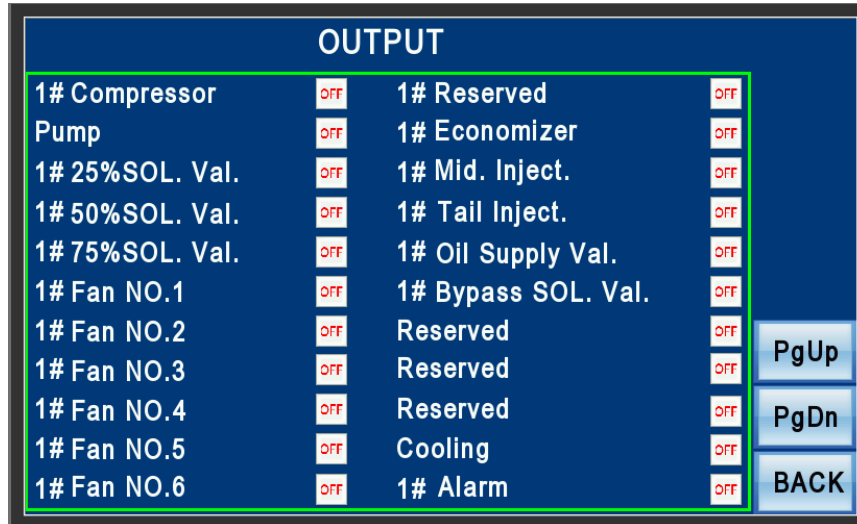

Output



“ON” as displayed indicates the output point is energized; “OFF” as displayed indicates the output point is de-energized.

✧ **Alarm**



Alarm information page

Click on  button in Main Page to enter the alarm information page.

If there is any alarm, the unit will execute alarm procedure action. The unit alarm status can't be removed until all of the alarms have been eliminated and alarm shutdown process has been finished. Click on  button and “Fault” in main page disappear, the unit returns to normal. If the warning message is more, please click on   to check. These in red color indicate the alarms which have not been eliminated; these in white color indicate the alarms which have been eliminated.

Note:

1. High-Pressure Protection is unable to reset in alarm information page, manual reset in the high pressure switch (installed in the discharge pipe) is needed.
2. Compressor and fan overload protection are unable to reset automatically, please check the relevant thermal relay in the control box to reset manually.

**History Alarm Information**

Click on  button in Alarm Page to enter history alarm information query information, as

shown in Picture 8.2. Max.5 warning messages can be recorded meanwhile. The messages will be updated automatically if there are more messages.

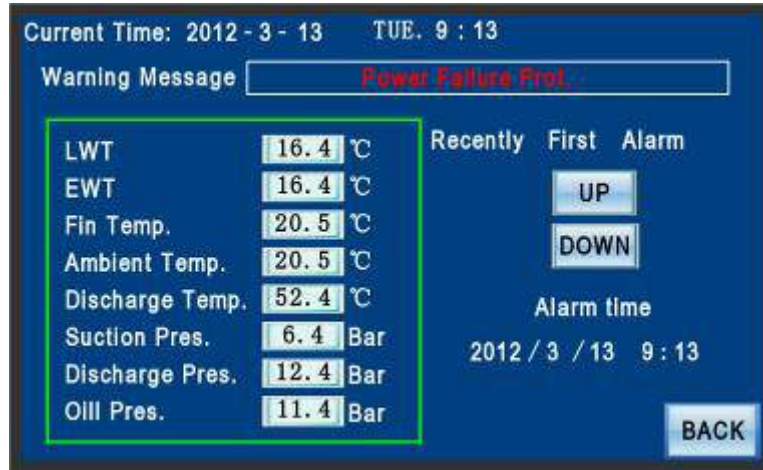

History alarm information query

Note:

1. The history alarm information record the unit operating parameters when there happen unit alarms during the compressor running.

NO.	Interface in English
1	Water flow fault
2	Anti-freeze Protection
3	1# High-pressure protection
4	1# Low-pressure protection
5	1# Compressor Motor Protection
6	1# Low Oil Level Protection
7	1# Contactor protection
8	1# Oil differential pressure protection
9	1# Compressor overload
10	1# Fans overload
11	Power Failure Protection
12	Entering water temp. sensor failure
13	Leaving water temp. sensor failure
14	Ambient temp. sensor failure
15	1# Fin temp. sensor failure
16	1# Discharge temp. sensor failure
17	2# Fin temp. sensor failure
18	2# Discharge temp. sensor failure
19	1# Suction pressure failure
20	1# Discharge pressure failure
21	2# Suction pressure failure
22	2# Discharge pressure failure
23	1# High discharge temp. protection
24	1# High Fin temp. protection
25	1# Differential pressure protection
26	1# Low Suction Pressure protection
27	2# High discharge pressure protection
28	1# Mode switch failure

29	Mode water temp. protection
30	1# EXV module failure
31	2# High pressure protection
32	2# Low pressure protection
33	2# Compressor motor protection
34	2# Oil level protection
35	2# Contactor protection
36	2# Oil differential pressure protection
37	2# Compressor overload
38	2# Fans overload
39	2# High discharge temp. protection
40	2# High Fin temp. protection
41	2# Differential pressure protection
42	2# Low Suction Pressure protection
43	2# High discharge temp. protection
44	2# Mode switch failure
45	2# EXV module failure
46	Invalid Address Number

✧ **Multi-units status**

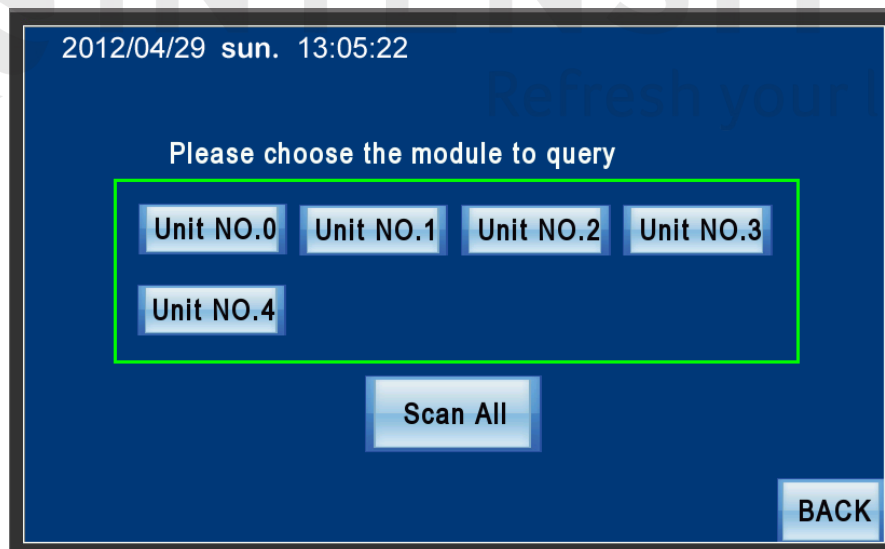

Multi units status

In this page, you can query the status of different modules through choosing the corresponding module button, also can check the status of all modules meanwhile through master-monitoring.

**Master-monitoring page**

Click on  to enter the next page, it will show the information of all connected units as following: The communication, alarm information, status, refrigerant type of each unit can be inquired in the following pages.

2012/04/29 sun. 13:05:22

	Communication	Alarm	Status	Defrosting	Refrigerant
0#(Master)		Normal	Stop		R134a
1#(slave)	Normal	Normal	Stop		R134a
2#(slave)	Normal	Normal	Stop		R134a
3#(slave)	Normal	Normal	Stop		R134a
4#(slave)	Normal	Normal	Stop		R134a

PgDn BACK

Click on  to enter the next page.

2012/04/29 sun. 13:05:22

	Finish Oil Heating	Restart Delay	Min. running time	LWT too Low	LWT too High	Debug
0#(Master)	NO	NO	NO	NO	NO	YES
1#(slave)	NO	NO	NO	NO	NO	YES
2#(slave)	NO	NO	NO	NO	NO	YES
3#(slave)	NO	NO	NO	NO	NO	YES
4#(slave)	NO	NO	NO	NO	NO	YES

PgUp BACK

Note:

- ⊖ Max.8 units can achieve combination control, the unconnected unit can access the combination control system at any time as long as the unit is powered on and connected with the system by communication cable.
- ⊖ The "Status" displays "Run" until the unit finish the starting action and enter the process of automatic energy adjustment, otherwise displayed "shutdown"



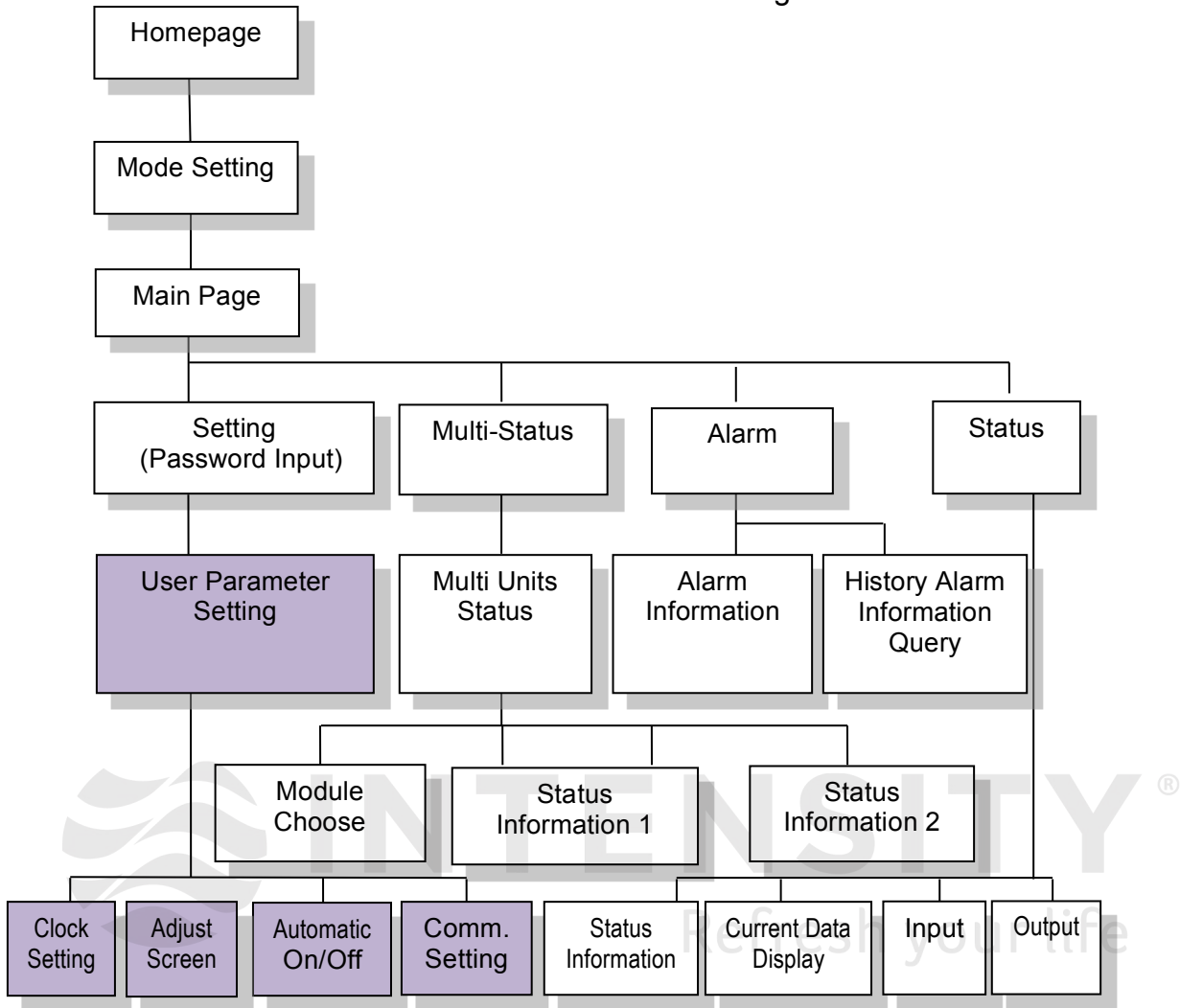

## 7. Control screen menu structure

Touch screen tree diagram



## 8. Safety protection

Name	Code	Brand	Setting Range	Location
Low-pressure Switch	YK-0.03/0.10-O-R-7000	JUNLE	0.03~0.10MPa	
High-pressure Switch 1	YK-2.1/1.7-C-R-7000	JUNLE	1.7~2.1MPa	
High-pressure Switch 2	YK-2.2/1.8-C-R-7000	JUNLE	1.8~2.2MPa	
Low-pressure Sensor (For main control board)	AKS33	Danfoss	-1~12bar	
High-pressure Sensor	AKS3000	Danfoss	0~30bar	

Note: Manual reset is needed for high-pressure switch.

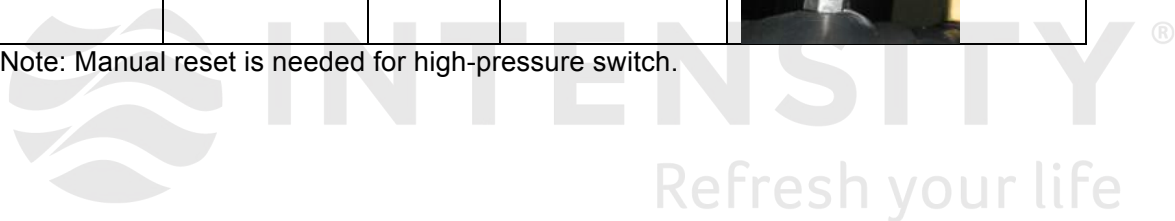

## IV. Electrical control

### 1. Electrical data

LSBLGWXXX/C		380	500	600	720	900	1000	1200	1420
Standard voltage	V	460V 3Ph 60Hz							
Voltage range	V	440~480							
Max. running current	A	233	307	352	419	540	614	704	838
Max. power consumption	kW	124	159	187	234	285	318	381	466
Rated current	A	185.6	248	279	336	433.6	496	558	672
Compressor A									
Locked rotor Amps.	A	465	650	805	805	465	650	805	805
Max. allowed current	A	330	420	450	450	330	420	450	450
Rated current	A	155.6	208	229	286	155.6	208	229	286
Rated power	kW	109.44	140.04	163	210	109.44	140.04	163	210
Compressor B									
Locked rotor Amps.	A	--	--	--	--	650	650	805	805
Max. allowed current	A	--	--	--	--	420	420	450	450
Rated current	A	--	--	--	--	208	208	229	286
Rated power	kW	--	--	--	--	140.04	140.04	163	210
Fan									
Full load Amps.(each)	A	5.2	5.2	5.2	5.2	5.2	5.2	5.2	5.2
Power input(each)	kW	2.2	2.2	2.2	2.2	2.2	2.2	2.2	2.2
Total input	kW	13.2	17.6	22	22	30.8	35.2	35.2	44
Crankcase heater									
Voltage	V	230	230	230	230	230	230	230	230
Total input	kW	0.3	0.3	0.3	0.3	0.6	0.6	0.6	0.6
Total Amps.	A	1.36	1.36	1.36	1.36	2.72	2.72	2.72	2.72

#### NOTE:

- 1.Customer to specify the exact nominal power supply available at site so that electrical components are selected accurately.
- 2.Main power must be supplied from a single field supplied and mounted fused circuit breaker.
- 3.The compressor crankcase heaters must be energized for hours before the unit is initially started or after a prolonged power disconnection.
- 4.All field wiring must be in accordance with local standards.
- 5.Neutral line required on 460V-3Ph-60Hz(5 wires) power supply.
- 6.Rated load Amps values are on nominal conditions.
- 7.The  $\pm 10\%$  voltage variation from the nominal is allowed for a short time, not permanent.

### 2. Electrical components introduction

#### 1) Moulded case circuit breaker

The mould case circuit breaker is mainly used in a non-frequently operated low voltage distribution line or used as a power switch in the switch cabinet. It can connect or disconnect a load circuit, isolate power, and provide protection for circuits, electric devices, and motors. In the case of overcurrent, overload, or short circuit, the circuit breaker disconnects the circuit automatically. The applied mould case circuit breaker provides overload and short circuit protection.



---

## 2) Power protector

This module is used to detect power supply and provide protection in case of phase loss, phase sequence, and under voltage of incoming line power, so as to prevent damage to the compressor or other components caused by power failure. Some models also provide protection for overvoltage and three phase imbalance.



## 3) Time relay and intermediate relay

The time relay is an automatic switch device which performs delayed control based the electromagnetic or mechanical principles. It controls the star delta switching time for the compressor contactor. The preset time is star operation time (6s). The coil voltage is AC 220V. The rated contact current is usually low and is used for controlling the loop only.

The intermediate relay delivers intermediate signals among control circuits to increase the number and capacity of contacts. Normally, the main control board output controls starting and stopping of loads such as motor and water pump by using the intermediate relay to drive the contactor coil. The coil power supply can be DC or AC. Our standard screw compressor model uses the AC220V coil.

## 4) Compressor and fan thermal overload relay

The thermal overload relay works based on the principle of heating effect of electric current. With inverse time limit action feature which is similar to the permissible overload feature of the motor, it is used to provide overcurrent protection for the compressor and fan. For compressor overload protection, the major loop current of the motor is converted to an AC 0-5 A current signal by the current mutual inductor. Then the thermal overload relay performs overload protection. For fan overload protection, the thermal overload relay is connected in series with the major loop.

## 6) .Current transformer and transducer

The current transformer transforms primary current with a larger value to secondary current with a smaller value for the purpose of protection or measurement. A current transformer with transformation ratio of 400/5 can transform 400A current to 5A.

A transducer transduces the measured current to DC voltage or DC current. After the current transformer transforms the current to AC 0-5 A current signals, the transducer outputs 4-20 mA analog signal based on the linear scale to the main control board.



## 7) Electronic expansion valve

The electronic expansion valve is equipped with a stepping motor which controls the valve status. A special-purpose electronic expansion valve control module is required to drive the electronic expansion valve.



## 8) Solenoid valve

When the solenoid valve is energized, the electromagnetic coil generates electromagnetic force to pull up the closed component from the valve seat and the valve is open. When the solenoid valve is powered off, the spring pushes the closed component to the valve seat once the electromagnetic force disappears and the valve is closed. Voltage of the solenoid valve washer is AC220V, and it is driven directly by the main control board output.

### 3. Electrical components parameter setting

#### 1) Moulded case circuit breaker

TEST key: to press to test whether the breaker is normal in stop condition



Tripping value

Unit Type	Compressor Startup Current	Maximum Running Current of the Entire Unit	Value		
			Ir	Class.	Isd
380	586	287	320	5	6
500	805	368	500	5	5
600	805	412	500	5	5
720	917	523	630	1 (Ir)	7
900	586+805	655	320+400	5	6
1000	805+805	368+368	500+500	5	5
1200	805+805	412+412	500+500	5	5
1420	917+917	523+523	630+630	1 (Ir)	5

Remarks: /

#### 2) Power protector

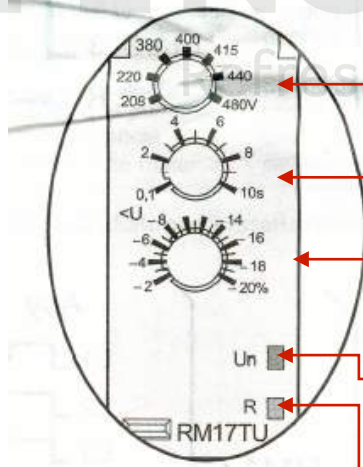

U<sup>..</sup> 380V

T<sup>..</sup> 6S

v U<sup>..</sup>

Power LED ^ on lighting

Running LED normal lighting; fault off

**Power protector use Schneider RM17TU type.**

- Select the voltage class. For standard units, the voltage is 380 V.
- Set the delay to 6s.
- ⊗ Set the under voltage value to 10%.

**Note: Set the processing parameters only when the system is powered off.**

### 3) Time Relay

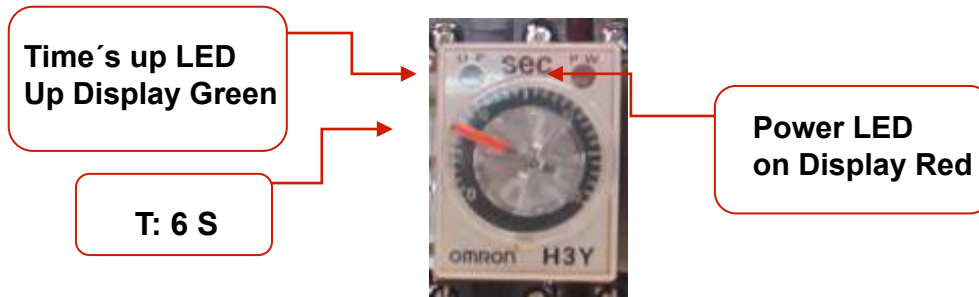

Time relay use Omron H3Y type.

### 4) Compressor and fan thermal overload relay

Thermal overload relay takes advantage of heating effect to protect the compressor and fans.

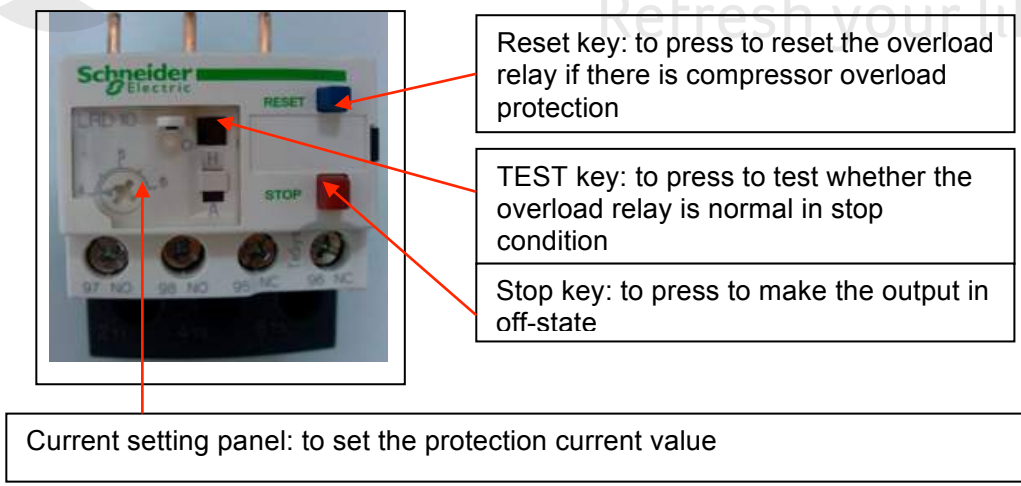
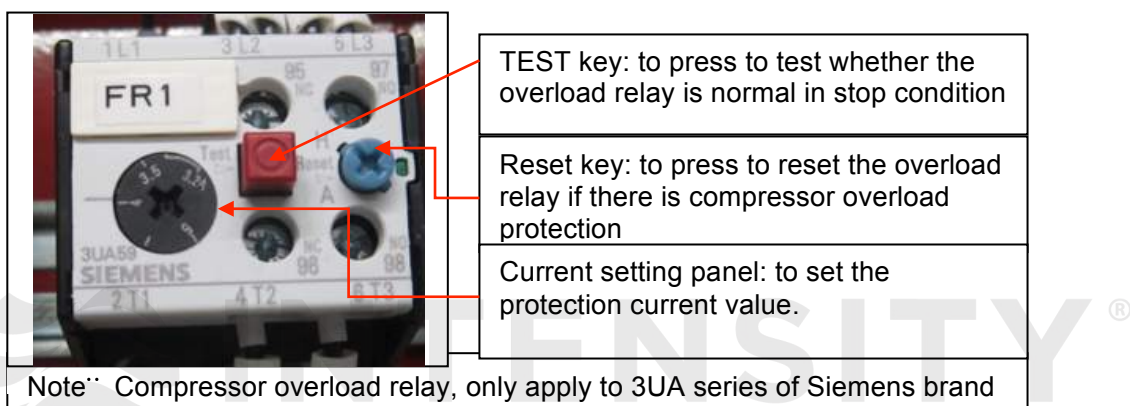

### Compressor thermal relay value:

The calculation of compressor overload value (transformation ratio of current mutual inductor is A/B) is as follows:

(Maximum running current of compressor/current mutual inductor A) x B = Thermal relay value of compressor

For example, if the maximum running current of compressor is 250 A, and the transformation ratio of current mutual inductor is 300/5,

Thermal relay value =  $(250/300) \times 5 = 4.17$

Note: Use a value that is smaller than the calculated one. For example, in the preceding calculation, the

calculated value is 4.17; in practice, set the value to 4.15.

Unit Type	Maximum Running Current of Compressor	Transformation Ratio of Current Transformer	Thermal Relay Value of Compressor
380	261	300/5	4.5
500	331	400/5	4.3
600	369	400/5	4.6
720	473	600/5	3.9
900	261+331	300/5+400/5	4.5/4.3
1000	331+331	400/5	4.3
1200	369+369	300/5	4.6
1420	473+473	400/5	3.9

**Fan motor thermal relay value:**

Unit Type	Fan quantity	Maximum Running Current of fan motor	Thermal Relay Value of fan motor
380	6	5.6	4.5
500	8	5.6	4.3
600	10	5.6	
720	10	5.6	
900	14	5.6	
1000	16	5.6	
1200	16	5.6	
1420	20	5.6	

**4) Main base controller DIP setting**

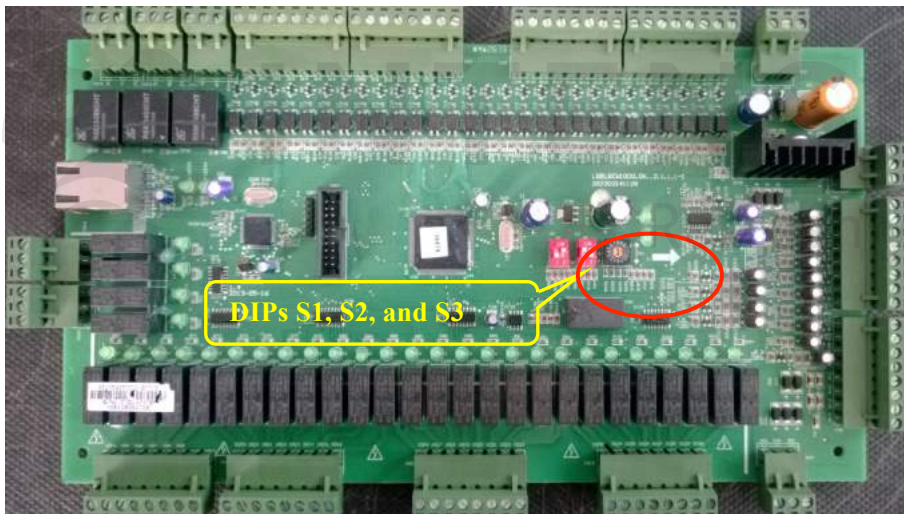

## 4. Field wiring

### 1) Wiring diagram

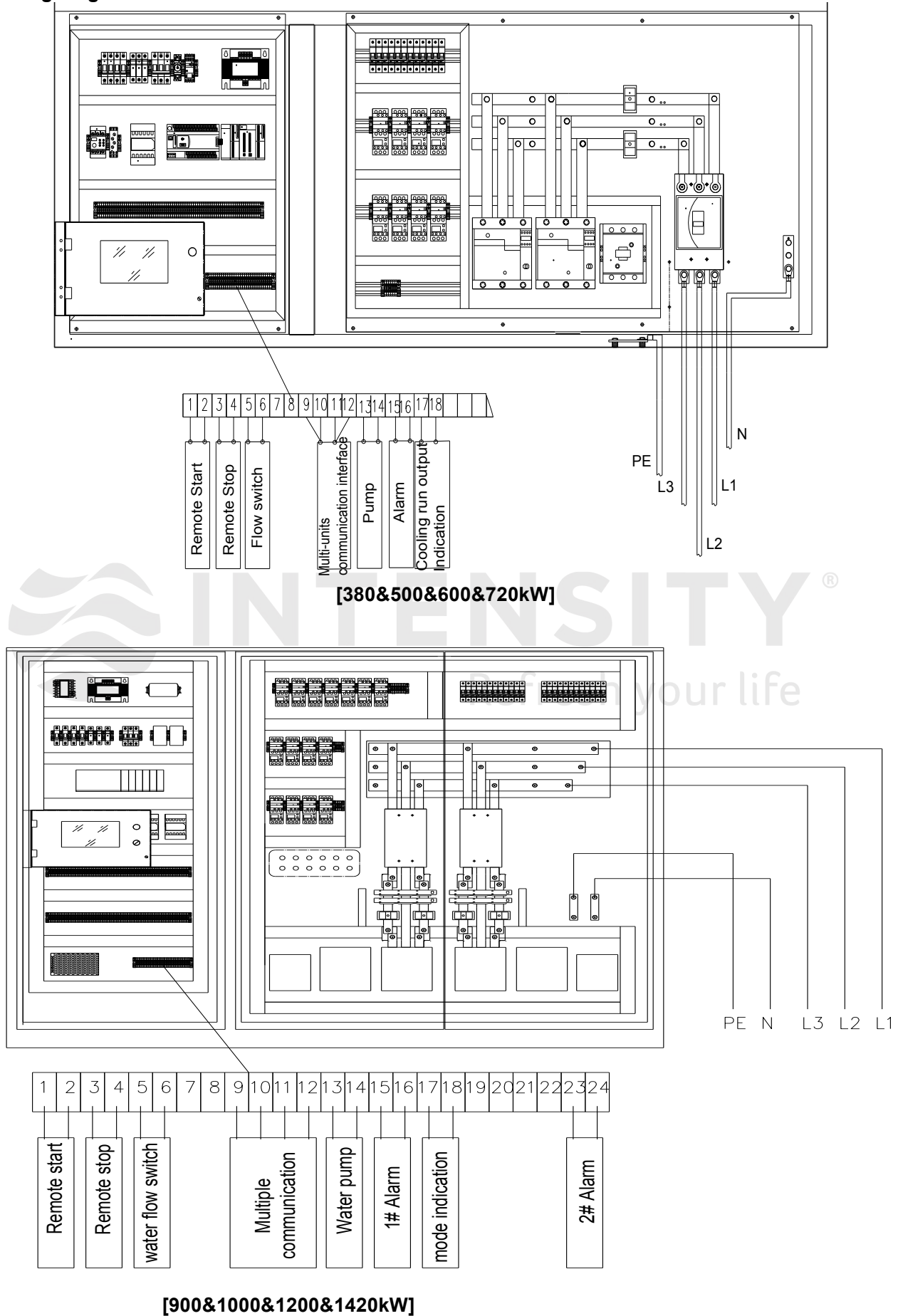



## 2) Recommended cable and mould case circuit breaker

Type	Electric cable (mm <sup>2</sup> )		Capacity of breaker (A)	Note: It is recommended that only copper-conductor cables are used in this unit. In high-altitude areas with high temperature, temperature derating should be considered, the capacity of breaker device should be increased properly.
	Phase line	PE line		
380	120	70	330	
500	240	120	500	
600	240	120	500	
720	2*185	2*120	630	
900	185+240	120+120	830	
1000	2*240	2* 120	1000	
1200	240+300	120+150	1000	
1420	2*400	2* 240	1260	

**Note:** The length of leading-in power cables in the unit cannot exceed 180 m.

## 3) Pump wiring

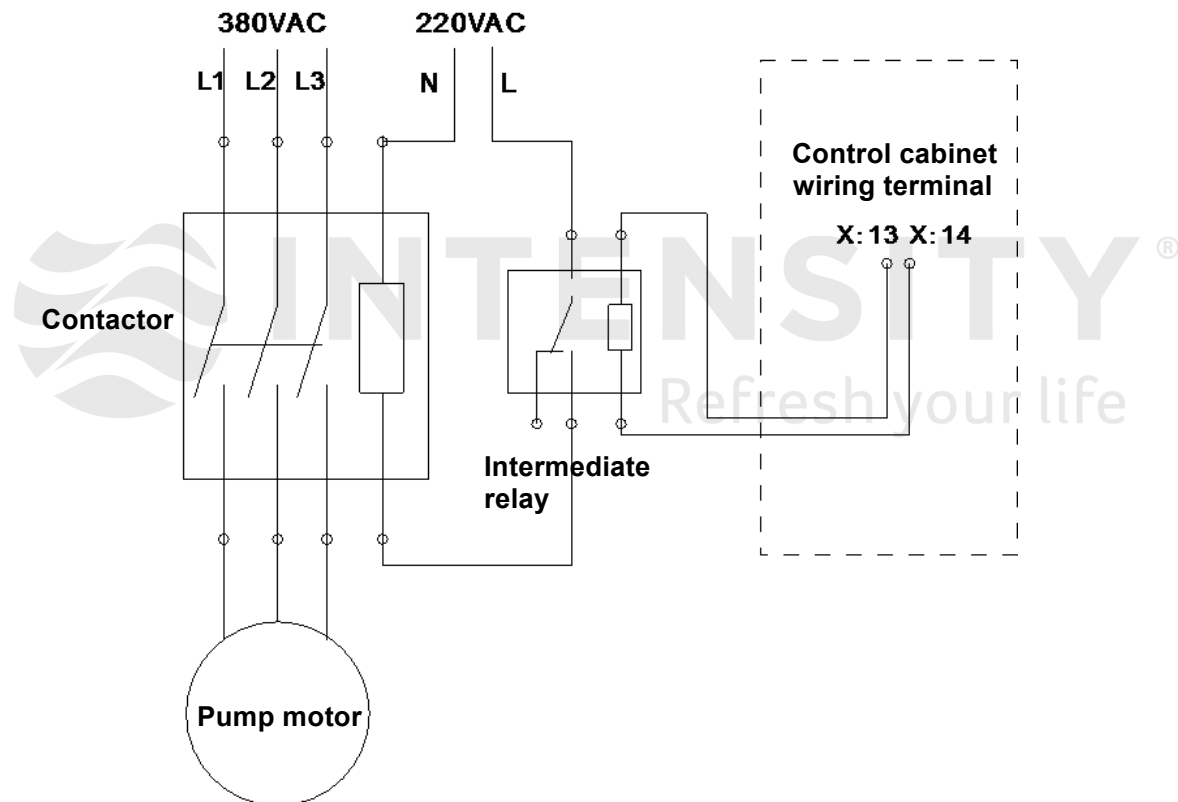

## 4) Water flow switch wiring

Typically, a water flow switch is installed in the pipe of cooling water system to monitor the flow status of cooling water in real time. Once the cooling water stops flowing, the water flow switch sends an alarm signal to the controller, which will perform timely processing to prevent accidents from occurring.

**Note:** A water flow switch is only a protection switch and cannot be used as a signal for unit power-on or power-off.

Alert status

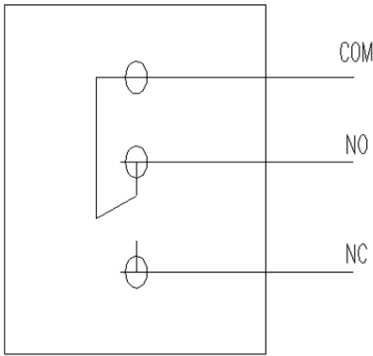

Water flow normal

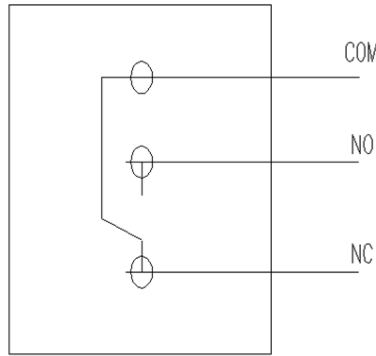

Connect the CDM NC of the water flow switch to customer terminals 5 and 6.

Water flow switch

## 6) Combination wiring

### Combination connection method

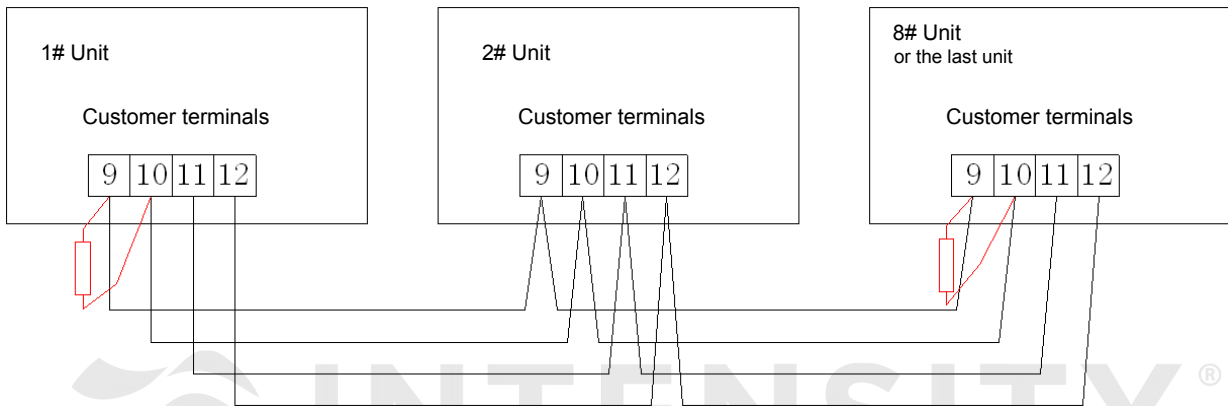

- ⊕ Terminal 9 is A+, terminal 10 is B-, terminal 11 is common ground, and terminal 12 is for grounding.
- ⊕ Communication cables must be connected in series. The adoption of any other topology may cause unstable communication or communication failure.
- ⊕ For the first unit and the last unit in a series circuit, a 120 ohm resistor must be connected between terminal 9 and terminal 10, as shown in the preceding figure.
- ⊕ Dual-head unit is considered a unit. A maximum of eight units can be connected.

### DIP settings for main base controller

Unit connection method			S1		S2		S3
			1	2	1	2	0-8
Combination	Master unit	Single	ON	OFF	ON	ON	0
		Double	1#	OFF	OFF	ON	OFF
	2#		OFF	ON	ON	OFF	0
	Slave	Single	ON	OFF	ON	OFF	Corresponding address (2-8)
Double		1#	OFF	OFF	ON	OFF	Corresponding address (2-8)
		2#	OFF	ON	ON	OFF	0

#### Notes:

⊕ Please power off the system after DIP settings.

**Note:** To use the combination function, software configuration is also required except for unit connection.

Click "Parameter Setting" on the homepage to access a new page (for password settings).

## 7) Others wiring

The wiring ports for remote start/stop, flow switch, water pump linked control, alarm indication, etc. are reserved in the electrical cabinet of the unit, with the numbers shown in the diagram below.

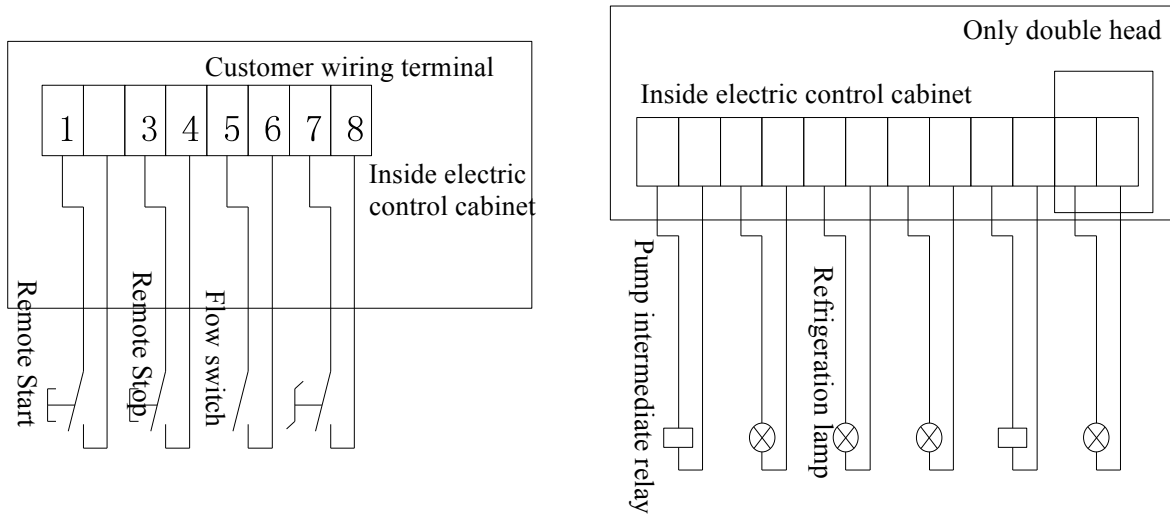

Remote start/stop switch need to use inching switch.

Lamp input 220VAC.



## V. Installation

### 1. Unit installation

#### 1).Lifting

- Hoist the unit according to the following chart strictly. The steel rope shall wind the lifting hook one circle to prevent steel rope slipping and causing danger when the weight is unbalanced.
- Must use enlargement pole prevent sling damage to the unit
- Security guard circle should be set up when hoist the unit, and also abide by the local safety regulations when hoist the unit. Prohibit non-staff from entering the security guard circle or staying under the unit and the hoisting crane.

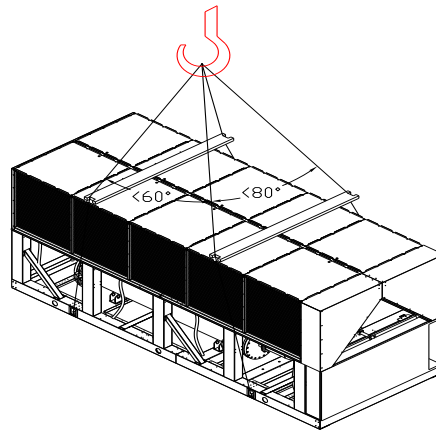

#### 2) Foundation

The installation foundation shall be designed by professionals according to the site conditions.

The installation foundation of the unit must be of a cement or steel structure, and shall bear the operating weight of the machine, and this face must be horizontal.

Please refer to the Diagram for Installation Foundation of Unit, place the steel plate and anti-vibration bush on the foundation accurately, and execute secondary grouting after installing the unit and foundation bolts together. The foundation bolts are generally 60 mm higher than the installation surface.

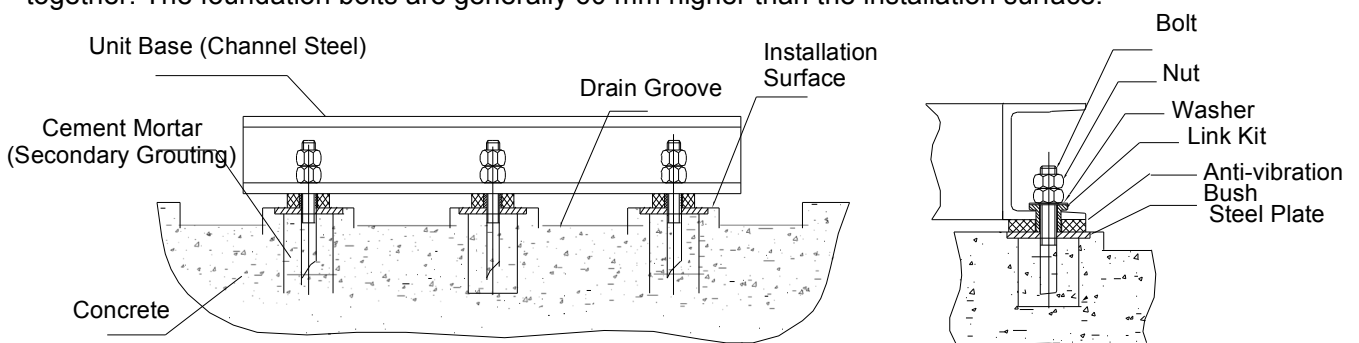

If the unit will be installed on the top of the building which vibration level should be restricted. It is recommended to use spring isolators as absorber, please refer to following diagram:

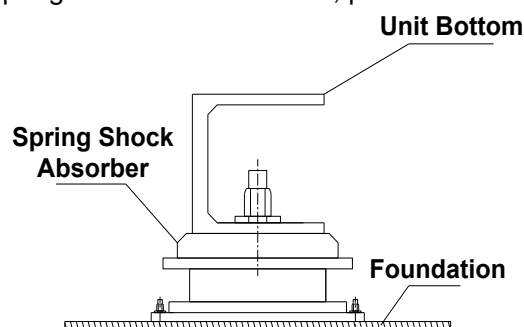

### 3) Dimensions & Vibration Isolators

Vibration isolators are recommended for all roof mounted installations or wherever vibration transmission is a consideration.

Neoprene Isolation is optional, it is recommended for normal installations and provides good performance in most applications for the least cost.

Spring isolators are level adjustable, spring and cage type isolators, mounted under the unit base rails.

Deflection may vary slightly by application.

Isolator model	Code	Brand
Spring isolator MHD-850	202502301043	Mei Huan (Yan Cheng City)
Spring isolator MHD-1050	202502301044	Mei Huan (Yan Cheng City)

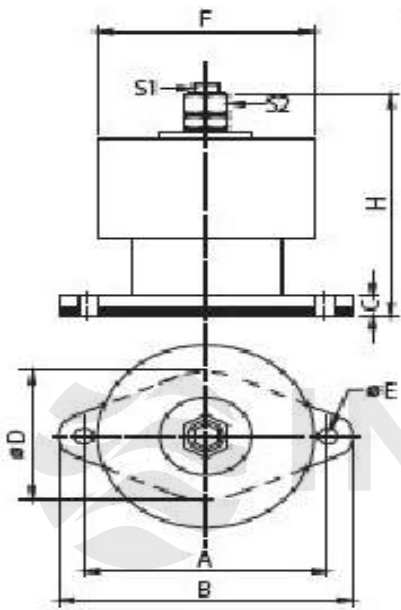

The housing of MHD series with aluminum-magnesium alloy material could prevent the vibration isolator from rustiness forever and enlarge the use life. The structure also has new improvement with an anti-side-force function for better stability and safety of unit. It can be freely adjusted as per balancing situation of unit to guarantee its work under all situations.

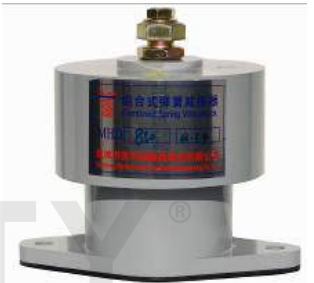

Technical data of MHD

MODEL	LOAD (kg)	LOAD (N)	DEFLECTION (mm)	VERTICAL (kg/mm)
MHD-850	850	8330	25	34.00
MHD-1050	1050	10290	25	42.00

MODEL	OUTER SIZE (mm)								
	A	B	C	ΦE	F	H	S1	S2	ΦD
MHD-850	165	200	13	12.5	147	165	M12*25	M20*60	104
MHD-1050	165	200	13	12.5	147	165	M12*25	M20*60	104

#### 4).Spaces

Reserve the spaces required for unit installation, operation and maintenance.

The installation place of the unit shall be free from the effects of fire, inflammables, corrosive gas or waste gas as much as possible; the ventilation space shall be reserved there; proper measures shall be taken to reduce noise and vibration whenever possible.

When the units are installed on the horizontal plane without obstacles, the longitudinal distance between the units shall be kept above 1m, the transverse distance between the units shall be kept above 1.8 m, and such distances shall be as large as possible; if there are obstacles at both sides of the unit, the distance between the unit and obstacles shall be kept above 1.8 m; if there are obstacles above the unit, the distance between the unit and obstacles shall be kept above 2.5 m.

The removable post for compressor service access must not be blocked at either side of the unit.

There must be no obstruction under the fans.

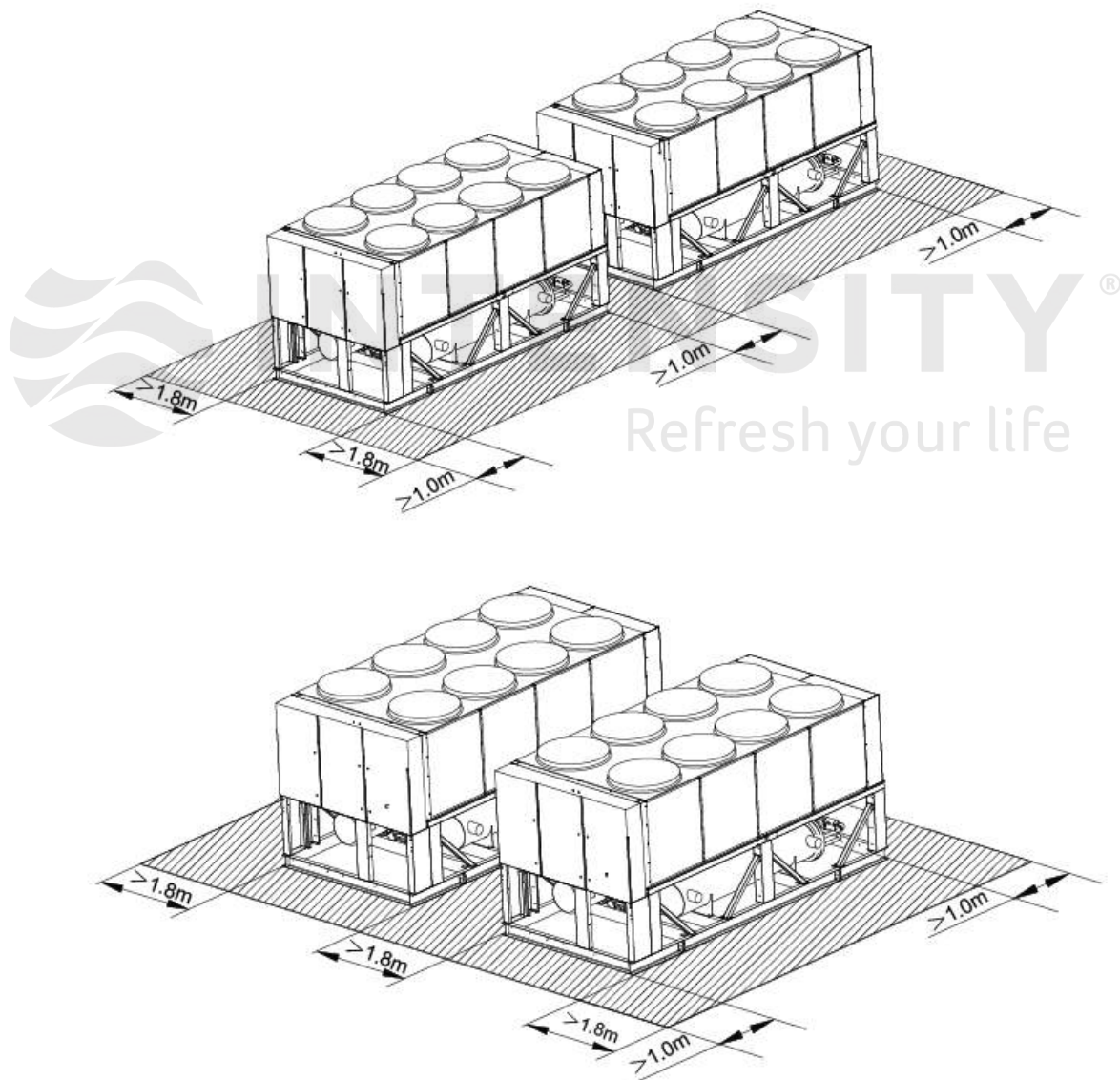

## 2. Water pipeline system installation

### 1) Water quality control

When industrial water is used as chilled water, little furring may occur; however, well water or river water, used as chilled water, may cause much sediment, such as furring, sand, and so on. Therefore, well water or river water must be filtered and softened in softening water equipment before flowing into chilled water system. If sand and clay settle in the evaporator, circulation of chilled water may be blocked, and thus leading to freezing accidents; if hardness of chilled water is too high, furring may occur easily, and the devices may be corroded. Therefore, the quality of chilled water should be analyzed before being used, such as PH value, conductivity, concentration of chloride ion, concentration of sulfide ion, and so on.

#### ※ Applicable standard of water quality for the unit

PH value	Total hardness	Conductivity	Sulfide ion	Chloride ion	Ammonia ion	Sulfate ion	Silicon	Iron content	Sodium ion	Calcium ion
7~8.5	<50ppm	<20 $\mu$ V/cm(25 $^{\circ}$ C)	No	<50ppm	No	<50ppm	<30ppm	<0.3ppm	No requirement	<50ppm

### 2) Performance adjustment factors

The antifreeze must be required according to anyone condition as following:

1. The outlet water temperature is below 5 $^{\circ}$ C;
2. The ambient temperature is below 0 $^{\circ}$ C;
3. Don't start up the unit for a long time.
4. The power supply was cut off and needn't change the water in system.

#### Ethylene and Propylene Glycol Factors

A glycol solution is required when the unit with condition as mentioned. The use of glycol will reduce the performance of the unit depending on concentration.

##### Ethylene Glycol

Quality of glycol (%)	modification coefficient				Freezing point $^{\circ}$ C
	Cooling capacity modification	Power modification	Water resistance	Water flow modification	
0	1.000	1.000	1.000	1.000	0
10%	0.993	0.997	1.013	1.019	-4
20%	0.984	0.994	1.149	1.051	-9
30%	0.975	0.989	1.343	1.092	-16
40%	0.969	0.984	1.624	1.145	-23
50%	0.961	0.978	2.026	1.213	-35

##### Propylene Glycol

Quality of glycol (%)	Modification coefficient				Freezing point $^{\circ}$ C
	Cooling capacity modification	Power modification	Water resistance	Water flow modification	
0	1.000	1.000	1.000	1.000	0
10%	0.99	0.992	1.029	1.013	-3
20%	0.979	0.983	1.167	1.035	-7
30%	0.964	0.975	1.364	1.063	-13
40%	0.95	0.967	1.648	1.098	-21
50%	0.925	0.96	2.056	1.145	-33

Units operating with glycol solutions are not included in the ARI Certification Program.

#### Altitude correction factors

Performance tables are based at sea level. Elevations other than sea level affect the performance of the unit. The decreased air density will reduce condenser capacity and reduce the unit's performance. For

performance at elevations other than sea level refer to below table Maximum allowable altitude is 1800meters.

### Evaporator temperature drop factors

Performance tables are based on a 5°C temperature drop through the evaporator. Adjustment factors for applications with temperature ranges from 3°C to 6°C in follow table. Temperature drops outside this range can affect the control system's capability to maintain acceptable control and are not recommended.

### Fouling Factor

ALTITUDE (m)	Fouling Factor							
	0.018m <sup>2</sup> °C /kW		0.044m <sup>2</sup> °C /kW		0.086m <sup>2</sup> °C /kw		0.172m <sup>2</sup> °C /kw	
	C	P	C	P	C	P	C	P
Sea level	1.042	1.028	1.029	1.020	1.000	1.000	0.977	0.995
600	1.027	1.037	1.014	1.029	0.986	1.009	0.964	1.004
1200	1.014	1.050	1.001	1.041	0.973	1.021	0.951	1.016
1800	1.000	1.060	0.987	1.052	0.960	1.031	0.938	1.026

C--Cooling capacity

P—Power

### 3) Design of the store tank in the system

a. kW is the unit for cooling capacity, L is the unit for (G) minimum water flow volume in the formula.

Comfortable type air conditioner

G= cooling capacity×2.6L

Process type cooling

G= cooling capacity×7.4L

b. In certain occasion (especially in manufacture cooling process), for conforming the system water content requirement, it's necessary to mount a tank equipping with a cut-off baffle at the system to avoid water short-circuit, Please see the following schemes:

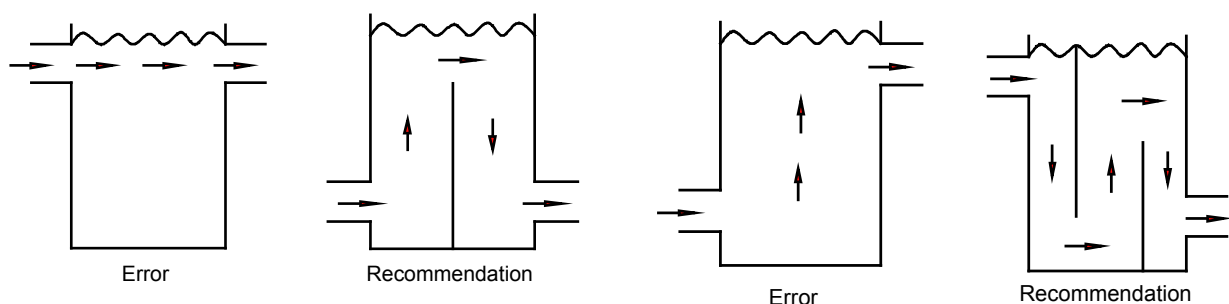

### 4) Water pipeline installation

Due to the variety of piping practices, it is advisable to follow the recommendations of local authorities. The installation and insulation of the water pipelines of the air conditioning system shall be designed and guided by design professionals, and confirm to the corresponding provisions of the HVAC installation specifications.

Basically, the piping should be designed with a minimum number of bends and changes in elevation to keep system cost down and performance up.



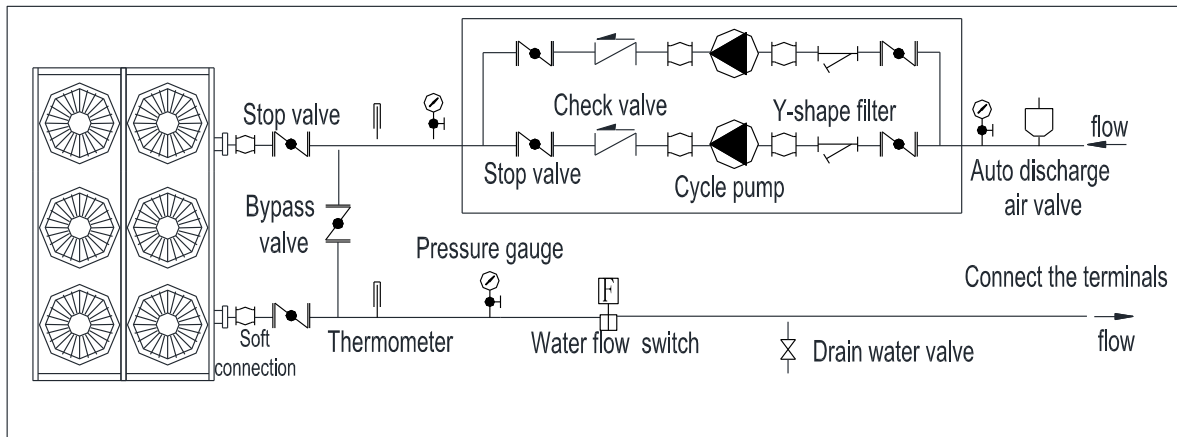

- 1) The water inlet pipeline and drain pipeline shall be connected according to the requirements of markings on the unit. Generally, the refrigerant pipe side of the evaporator is the chilled water outlet side.
- 2) The chilled water pipeline system must be provided with the soft connection, thermometer, pressure gauge, water filter, electronic scale remover, check valve, target flow controller, discharge valve, drain valve, stop valve, expansion tank, etc.
- 3) The water system must be fitted with the water pump with appropriate displacement and head, so as to ensure normal water supply to the unit. The soft connection shall be used between the water pump, unit and water system pipelines, and the bracket shall be provided to avoid stress on the unit. Welding work for installation shall avoid damage to the unit.

(1) Determination of water pump flow:

$$\text{Flow (m}^3/\text{h)} = (1.1 \sim 1.2) * \text{Unit Cooling Capacity (kW)} / 5.8$$

(2) Determination of water pump head:

$$\text{Head (m)} = (\text{Unit Resistance (see product parameters)} + \text{Resistance at Maximum End of Pressure Drop (see product parameters)} + \text{Pipeline Resistance (length of the least favorable loop pipe} * 0.05) + \text{Local Resistance (length of the least favorable loop pipe} * 0.05 * 0.5)) * (1.1 \sim 1.2)$$

- 4) The flow switch must be arranged on the drain pipe of the evaporator. The flow switch shall be interlocked with the input contact in the control cabinet. Its installation requirements are as follows:

- (1) The flow switch shall be installed on the pipe vertically.
- (2) The straight pipe section at each side of the flow switch shall have a length that is at least 5 times the pipe diameter; do not install it near the elbow, orifice plate or valve.

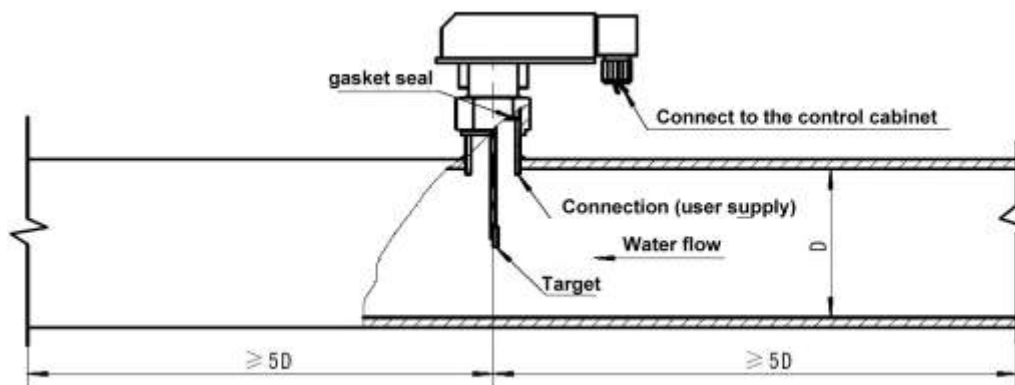

- (3) The direction of the arrow on the flow switch must be consistent with the direction of water flow.
- (4) In order to prevent vibration of the flow switch, remove all air in the water system.

- 
- (5) Adjust the flow switch to keep it in open state when the flow is lower than the minimum flow (the minimum flow is 70% of the design flow). When the water flow is satisfied, the flow switch shall keep in closed state.
  - 5) The water filter must be installed before the water inlet pipeline of the unit, which shall be provided with a 25-mesh screen. This will aid in preventing foreign material from entering and decreasing the performance of the evaporator.
  - 6) A strainer should be placed for enough upstream to prevent cavitation at the pump inlet (consult pump manufacturer for recommendations). The use of a strainer will prolong pump life and help maintain high system performance levels
  - 7) The flushing and insulation of the water pipelines shall be carried out before it is connected with the unit, so as to prevent dirt from damaging the unit.
  - 8) The design water pressure of the water chamber is 1.0Mpa. Use of the water chamber shall be not exceeding this pressure in order to avoid damaging the evaporator.
  - 9) The expansion tank shall be installed 1~1.5m higher than the system, and its capacity accounts about 1/10 of the water amount in the whole system.
  - 10) The drain connection is arranged on the evaporator cylinder. The drain outlet has been equipped with a 1/2" plug.
  - 11) The auto discharge air valve is arranged between the high point of the pipeline and the expansion tank.
  - 12) The thermometer and pressure gauge are arranged on the straight pipe sections of the water inlet pipeline and drain pipeline, and their installation places shall be far away from the elbows. The pressure gauge installed shall be vertical to the water pipe, and the installation of the thermometer shall ensure that its temperature probe can be inserted into the water pipe directly.
  - 13) Each low point shall be fitted with a drain connection so as to drain the remaining water in the system. Before operating the unit, connect the stop valves to the drain pipeline, respectively near the water inlet connection and drain connection. The by-pass pipeline shall be provided between the water inlet pipe and drain pipe of the evaporator, convenient for cleaning and maintenance. Use of flexible connections can reduce vibration transfer.
  - 14) The chilled water pipeline and expansion tank shall be subjected to insulation treatment, and the maintenance and operation part shall be reserved on the valve connections.
  - 15) After the air-tightness test is carried out, and the insulation layer is applied on the pipeline, so as to avoid heat transfer and surface condensation; the insulation layer shall be covered by moisture-proof seal.
  - 16) Any water piping to the unit must be protected to prevent freezing. There are reserved terminals for the auxiliary electrical heater. Logic in PLC will transmit ON/OFF signal by checking the leaving evaporator water temperature.

Note: The unit only supply ON/OFF signal, but not the 220V power. If a separate disconnect is used for the 220V supply to the cooler heating cable, it should be clearly marked so that it is not accidentally shut off during cold seasons

- 17) If the unit is used as a replacement chiller on a previously existing piping system, the system should be thoroughly flushed prior to unit installation and then regular chilled water analysis and

---

chemical water treatment is recommended immediately at equipment start-up.

- 18) Power on the chilled water pump, and inspect its rotation direction. The correct rotation direction shall be clockwise; if not, re-inspect the wiring of the pump.
- 19) Start the chilled water pump to circulate water flow. Inspect the water pipelines for water leakage and dripping.
- 20) Commission the chilled water pump. Observe whether the water pressure is stable. Observe the pressure gauges at the pump inlet and outlet, and the readings of the pressure gauges and the pressure difference between the inlet and outlet change slightly when the water pressure is stable. Observe whether the operating current of the pump is within the range of rated operating current; inspect whether the resistance of the system is too large if the difference between the operating current and rated value is too big; eliminate the system failures until the actual operating current is satisfied.
- 21) Inspect whether the water replenishing device for the expansion tank is smooth, and the auto discharge air valve in the water system enables auto discharge. If the discharge air valve is a manual type, open the discharge valve of the chilled water pipeline to discharge all air in the pipeline.
- 22) Adjust the flow and inspect whether the water pressure drop of the evaporator meets the requirement of the unit's normal operation. The pressure at the chilled water inlet and outlet of the unit shall be kept at least 0.2MPa.
- 23) The total water quantity in the system should be sufficient to prevent frequent "on-off" cycling. A reasonable minimum quantity would allow for a complete water system turnover in not less than 15 minutes.

### 3. Wiring installation

#### **WARNING:**

In order to prevent any accident of injury and death during the site wiring, the power supply shall be cut off before the line is connected to the unit.

Wiring must comply with all applicable codes and ordinances. Warranty is voided if wiring is not in accordance with specifications. An open fuse indicates a short, ground, or overload. Before replacing a fuse or restarting a compressor or fan motor, the trouble must be found and corrected.

- (1) Copper wire is required for all supply lines in field connection to avoid corrosion and overheat at the connection of terminals. The lines and control cables shall be separately paved and equipped with protective pipes to avoid intervention of supply line in control cable.
- (2) Power section: It is required to connect the power supply cable to the control cabinet of the unit, when it arrives at the jobsite. The power supply cable is connected to the terminals of L1, L2, L3, N and PE and the terminals need to be fixed again after 24h running (the minimum allowed time). Please seal the entering wiring hole after users installed the main power wires, in order to avoid the dust entering into electric control cabinet.

Caution: it is suggested that to use appropriate tools to make sure there is a enough height to install the main power wires if the basement is higher than 200 mm.

- (3) Breaking isolation switches should be added between the power cord of users and the unit. The

---

capacities of the breaking isolation switches recommended are as follows.

- (4) Attention: **refrigerant selection:** the previous software settings are replaced by the current hardware settings to avoid the possibility of improper operation of the software leading to wrongly selected refrigerant and damage to the unit.
- (5) Short circuit 1X: 35/1X: 36 on the wiring terminal 1X in the cabinet and set R22 refrigerant for the unit, or, R134a is used for the unit.
- (6) In order to avoid wrong control in field connection, the liquid control circuit (24 V) shall not be in the same conduit with the lead wire of the voltage higher than 24 V.
- (7) The control circuits of various units are all 220 V, and for the wiring ways of the control circuits, please refer to the wiring diagrams supplied along with the units.
- (8) A unit consists of master compressor and slave compressor communicating via shield wire protected by sleeve and separated from supply line.
- (9) The control output cable to be connected on site shall be AC250V-1mm<sup>2</sup>, and 0.75mm<sup>2</sup> shield wire (24 V) shall be used for control signal line.
- (10) Attention: Read the electrical wiring principle diagram and connect the wires strictly according to the wiring terminal diagram. Three-core shield cable (RVVP3×0.75mm<sup>2</sup>) shall be used for the connection of the temperature sensor. Common two-core cable (RVV2×0.75mm<sup>2</sup>) shall be used for the connection of flow switch to connect to the NO contact of the switch, i.e. the opening point when waterless. Two buttons can be connected to the external of remote start and stop.
- (11) If the customer desires the linked control of the water pump, connect the water pump as shown in the diagram, where an intermediate relay is required. If the function of linked control of water pump is not needed, ensure that the water pump is started before starting the machine.  
**CAUTION:** An independent power supply box needs to be equipped with the power supply of the water pump.
- (12) The wiring ports for remote start/stop, flow switch, cool/warm switch, water pump linked control, alarm indication, etc. are reserved in the electrical cabinet of the unit, with the numbers shown in the diagram below.
- (13) Passive inching button is used for remote start and stop, and the flow switch must be connected to the NO contact, or the machine cannot be started.  
Passive holding switch is used for cool/warm switch, e.g. common selection switch. Controls of large power electrical appliances such as water pump and user electric heating must be interfaced with a relay, or the PLC might be burned. Other outputs can be directly connected to indicator lamps or alarms.

## VI. Commissioning

### 1. Pre start-up

#### (1) Electrical system inspection

Inspect whether power distribution capacity is compliant with the power of the unit before the first start-up, and whether the diameter of the selected cable can bear the maximum working current of the master compressor.

#### The max economical conveying distance:

The max loading time in a year ( h )	Copper core length(m)
<3000h	264
3000~5000h	294
>5000h	331

- 2) Inspect whether the electric mode is compliant with that of the unit, three-phase five-line (three phase lines, one zero line and one earth wire,  $380V\pm 10\%$ ).
- 3) Inspect whether the maximum phase voltage unbalance is compliant with the requirement, 2% for the maximum permissible phase voltage unbalance and 5% for the phase current balance. The machine must not be started up when the phase voltage unbalance exceeds 2%. If the measured unbalance% is excess, the power supply sector shall be informed of immediately.
- 4) Inspect whether the supply circuit is the compressor is firmly and properly connected, and tighten it if there is any looseness. The screws might be loose due to the factors such as long-distance transport and hoisting of the master compressor. Or, the electrical elements (e.g. air switch, AC contactor, etc.) in the control cabinet of the master compressor and the compressor might be damaged.
- 5) Carefully inspect all the electrical lines with a multimeter, and whether the connections are properly installed. Carry out measurement in mega ohm and ensure that there is no short circuit at the shell. Inspect whether the earth wire is properly installed, and whether the insulation resistance to ground exceeds  $2M\Omega$ . And inspect whether the supply line meets the requirement of capacity.
- 6) Inspect whether disconnection switch is installed to the supply line of the supply unit.
- 7) Carry out complete inspect for all connections of the main circuit in the control cabinet and all external connections of the control circuit before power connection (e.g. oil heater, compressor electronic protection, circulatory water temperature sensor, target-type flow switch connection, water pump linked control, communication line connection, etc.); inspect the bolts of the wiring terminal for looseness. Inspect whether various electric meters and appliances are properly installed, complete and available. Inspect the interior and exterior of the electrical cabinet, especially various wiring ports, for cleanness. If the communication lines of the controller and control screen are damaged, refer to the diagram below.
- 8) After the inspection for all the above items is complete, connect the control cabinet and the supply indication lamp will light up, indicating that the oil heater is working. Observe whether the phase loss protection is in normal condition, if it is (green light on), close the single-pole switch (QF2) in the control cabinet, then the control circuit begins working, and the touch screen and controller are used

in operating.

## (2) Refrigeration System Inspection

- 1) The discharge line valve and suction line valve of the compressor must be fully open (turn anticlockwise to open) and the cores shall be tightly locked to prevent leakage of refrigerant.
- 2) Inspect whether moisture content of the system exceeds the limit  
Excessive moisture content in the refrigerant system of the unit might cause ice block, copper plating, etc. that would seriously affect the safety of the unit. Therefore, the dryness of the refrigerant system of the unit shall be inspected from the sight glass before and during operation of the unit, purple indicating dry, and pink moist, as shown in the below figure. When the color turns to red, the filter core in the unit shall be replaced with a dry one.
- 3) Sufficient lubricating oil in the oil tank (not lower than 1/2 of the oil level in the high oil immersion lens), and no deterioration (blackness).  
Inspect the oil level and quality before start-up for the two factors have direct impact on the performance and reliability of the unit. There must be sufficient lubricating oil in the unit. And during the shutdown of the unit, the high oil immersion lens must be full of oil.  
When the unit is in stable operation, the oil level in the high oil immersion lens should be at least above the 1/2 position. And there shall be no deterioration (blackness) of the lubricating oil, or else, qualified lubricating oil shall be changed before operating the unit.
- 4) Coil fin cooling fan shall rotate in correct direction without reverse rotation or shutdown.  
Before operation of the unit, inspect whether the fan networks are deformed under stress, whether there is friction and collision between the networks and the blades, whether there are foreign matters in the network, and whether the fin is deformed or damaged caused by collision.

There should be no deformation of the fan guard or foreign matters in it.



Operate the fans one by one before operating the unit, and inspect whether there is abnormal noise in the fan caused by poor lubrication of the bearing or friction of foreign matters, and whether the fan rotates reversely or does not rotate.

- 5) Inspect whether the directional elements such as one way valve, solenoid valve, electronic expansion valve, etc. are installed properly. The directions of the one way valve and solenoid valve are indicated on the valves. As for the thermostatic expansion valve and electronic expansion valve, if the valves are upward, the direction is generally high-in and low-out.
- 6) Inspect whether the pressure sensor stop valve, dry filter front/rear angle valve, liquid/air sampling stop valve and injection stop valve, etc. are all open.

When the unit stops, the high and low voltages shall be almost the same. After the start-up, the low voltage decreases, and the high voltage increases. If there is no voltage change certain time after

the start-up, inspect whether the liquid/air sampling stop valve is open.

- 7) After the unit is installed and before connected, it is required to tighten the connections in the electrical cabinet of the unit one by one.
- 8) Inspect the bolts of the unit for looseness.

After the unit is transported and installed, it is required to inspect whether the fixing bolts of the unit (e.g. fixing bolts at compressor base angle, at post and beam of the unit, and at pipe clamp, etc.) and of the electrical elements (e.g. fixing bolts of PLC and of insulating transformer, and connection bolts of upper/lower terminals of AC contactor, etc.) are firmly fixed.

- 9) Inspect the looseness of the connections in the electrical cabinet, especially the electric part in the cabinet. The parts connected by bolts might be loose due to transportation. If there is any looseness, tighten it to avoid burnout of circuit or element caused by poor contact.

Inspect the looseness of the terminals and poor contact caused by vibration and collision during transportation and installation (especially the electric terminals are firm and reliable before electrification).

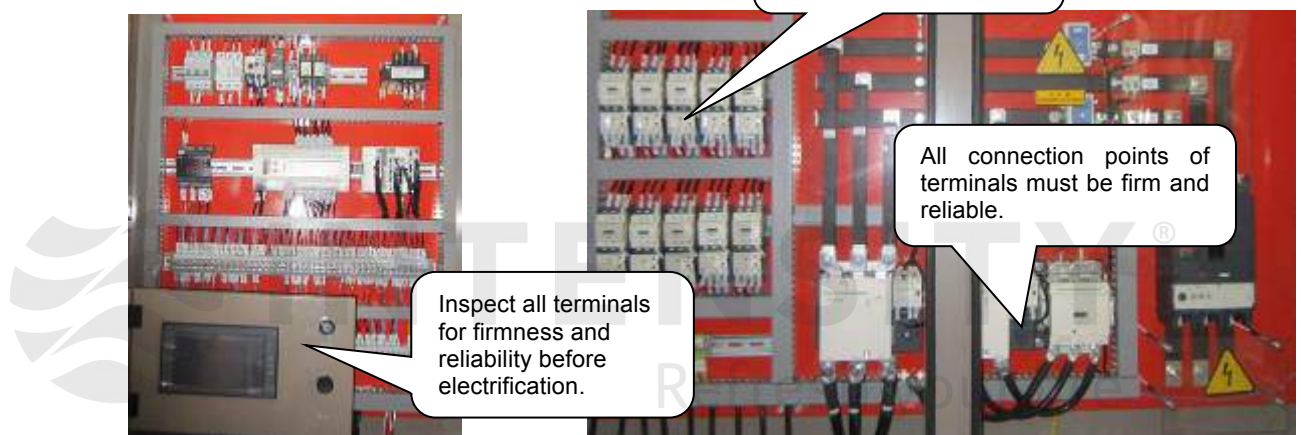

Inspect whether there is poor contact and short circuit caused by dust, moisture, etc. in the electrical cabinet, and whether the values of all temperature sensors are normal. During the shutdown of the machine, the indicated temperatures of discharge, fin, and the environment shall be almost the same, and the entering and leaving chilled water temperatures shall be almost the same.

- 10) Before the unit leaves the factory, the control cabinet is well connected with main motor, electrical actuator, and sensor elements of pressure temperature, etc. Therefore, the wiring on site for the user is very simple. Only the chilled water flow switch line and chilled water pump linked control line (control contact is active) need to be connected. For the detailed connection way, please refer to the circuit wiring diagram in the operation manual for the unit. (The attached circuit diagram represents the case of air-cooled heat pump unit for user's reference, as for the details, the operation manual supplied with the unit shall be final.)

- 11) Target-type flow switch is set on the chilled water pipeline which shall be installed at the outlet of the chilled water. The NO contact of the target-type flow switch shall be connected to the control circuit as per the wiring diagram.

Note: Disordered water flow may lead to wrong action of the flow switch; therefore, the control cabinet will command the unit to stop after receiving continuous disconnection signals during 10 s.

- 12) The tube where the temperature sensing probe is installed shall be filled with lubricating oil or other grease that will not freeze at the temperature of the leaving chilled water for the convenience of heat

transfer. Thermostatic insulation and enclosing measures shall be taken for the temperature sensing device.

Inspect whether there is temperature deviation for the entering and leaving water temperature sensor caused by insufficient heat transfer oil in the thermostatic pipe.

## 2. Start-up

- 1) High/low voltage value of the system. In the case of the unit shut-down and waterless in a long time, the liquid and gas of the system shall be equivalent and close to the saturation pressure corresponding to the current ambient temperature. The correlation of saturation temperatures and pressures (the pressures in the list are gage pressures, among which, the atmospheric pressure is 0.1MPa) of R134a refrigerant is shown in appendix 1:

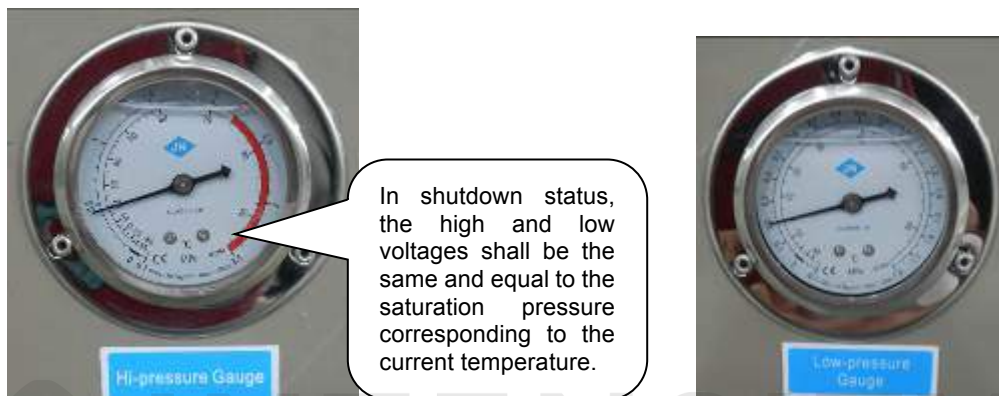

In the pressure gauge scale, taking the right figure for example: the outside values are pressure values (unit: bar), and the inside values indicate saturation temperatures of refrigerant R134a respectively under the relative pressure. The types of refrigerants indicated in different pressure gauges might differ. [Table 1]

Refrigerant temperature °C	R134a refrigerant pressure (Gage pressure) MPa	Refrigerant temperature °C	R134a Refrigerant pressure (Gage pressure) MPa
0	0.19	25	0.57
5	0.25	30	0.67
10	0.32	35	0.79
15	0.39	40	0.92
20	0.47		

If the high/low voltage deviates much from the saturation pressure corresponding to the current temperature (more than 2bar), maybe there is leakage or insufficient refrigerant in the system.

- 2) Inspect whether the oil heating of the unit is normal.

Before start-up, it is necessary to inspect whether the oil heating in the unit is available, and whether there is the condition that the oil heater does not work because of no power supply. It is particularly important in winter when the temperature is low and the failure of oil heating might lead to poor lubrication of the unit. The optimum working temperature for current types of lubricating oil is generally around 40°C.





Compressor oil heater is working when the unit is

- 3) Inspect whether there is alarm for trouble of the display screen. If there is, the trouble must be corrected.
- 4) Inspect the electronic expansion valve control module for alarm trouble.
- 5) Inspect whether various temperature points displayed on the display screen are within the normal range.

Before the operation of the unit, the showed temperatures of discharge, fin and the ambient temperature are close to the current actual ambient temperature, and whether the entering and leaving water temperatures are close to the water temperature at the user side. If there is any obvious deviation of the above temperatures, inspect whether the temperature sensor is in normal condition and whether the connection is firm and reliable.

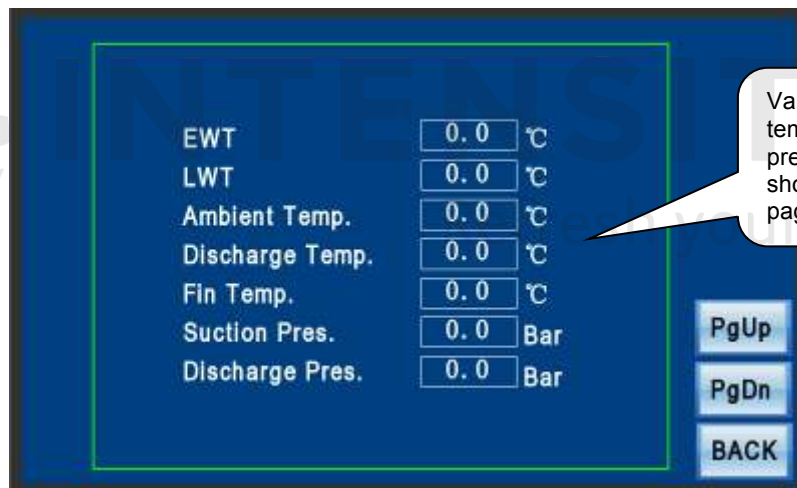

Values of various temperature and pressure points showed in the main page of the unit.

- 6) Start on pump. Inspect whether the flow in the water pump meets the requirements of the unit.
- 7) Inspect whether the power supply of the unit is stable.
- 8) Start on chiller.
- 9) Running parameters

The maximum range of parameters for normal operation of R134a refrigerant unit. See below table for the maximum range of performance parameters of R134a refrigerant:

Working Condition	Optimal range	Limit Range
Discharge temp. °C	60~80	<110
Suction temp. °C	3~12	--
Condensation temp. °C	46~51	<65
Evaporation temp. °C	-1~4	<15
Suction super-heating degree °C	4~8	~
Discharge pressure MPa	1.2~1.4	<1.8
Suction pressure MPa	0.28~0.38	<0.38
Discharge super-heating degree °C	10~30	
Super-cooling degree °C	2~8	



**INTENSITY**®

Refresh your life

## VII. Maintenance

In order to ensure the long term safe operation, to extend the service life of unit, reduce the failure and repair, should be regularly maintained and checked on the unit

### 1. Daily maintenance

- 1). Switch machine daily by local and remote two modes, the local switch unit set see previous page 1 HMI operation local switch part, HMI key to open for local mode switch machine, electric control box on the door of the emergency stop switch used in machine repair, debugging or emergency shutdown, usually do not use.
- 2). During operation of the unit, should irregularly check the water temperature, oil level of compressor, high and low pressure, voltage, current and so on, such as abnormal timely find out the reasons, troubleshooting.

### 2. Maintenance

#### 1).Schedule

Maintenance items		Maintenance frequency	Qualify standards (Settlement)	Note
I. General	Noise	Anytime	Judge whether there is abnormal sound by hearing;	Watch from one meter away from the center of the Chiller;
	Vibration	Anytime	Watch whether the swings of distribution pipes and components are too large	
	Voltage	Anytime	Rated voltage is within $\pm 10\%$	
II. Appearance	Clean	Anytime	Keep it clean anytime	
	rust	Anytime	using an iron brush to remove rust, besmear again the antirust paint	
	Calm	Anytime	Lock each snail	
	Insulation material flakes	Anytime	Using adhesives sticky	
	Water leak	Once/ Month	Check whether the exhaust water pipe is blocked	
III. Compressor	Noise	Anytime	Whether there is abnormal sound when starts up, runs or stops	
	Insulation resistance	Once/ Year	Above $5M\Omega$ is required when testing with DV500V high resistance meter	
	Shockproof rubber gets old	Once/ Year	Flexible when pressed with hands is qualified	
	Medium check	Once/3000 hours	Pay attention to the noise libation and oil level	
	Medium check	Once/6000 hours	Confirm the action of safety device and protection device	
IV. Fin heat exchanger	Fan	Anytime	Normal wind amount, high pressure within the normal range	
	Clean situation	Once/Month	Normal wind amount, high pressure within the normal range	
V. Shell-and-tube heat exchanger	Water flow of the user side	Anytime	Within $\pm 5\%$ of the standard	
	Temperature	Anytime	Within the standard	
	Antifreeze concentration	Once/Month	Make sure it is set above the set concentration	
	Water quality	Once/Month	Within the standard	Refer to water quality furring relations drawing
	Purity	Anytime	The low pressure is within the standard when refrigerating	

Maintenance items		Maintenance frequency	Qualify standards (Settlement)	Note
	Drainage	Anytime	Drain all the water if it is not used for a long time	Drain water in the distribution pipe
VI. High and low pressure switch	Action	Once/Month	Check according to 'Protection Devices Action Value'	Whether the match point is good
VII. Pressure Gauge	Finger	Once/ Half of a year	Compare with correct pressure gauge	
VIII. Globe valve	Action	Once/Month	Smooth action on globe valve switch	
IX. Refrigeration circle	Refrigeration media leak	Once/Month	Check whether there is refrigeration media leakage inside the Chiller or at the distribution pipe connecting points. Let out all the water inside the shell-and-tube heat exchanger, and check whether there is any leakage at the water inlet or outlet.	Use the electronic leak detector, or blowtorch leak detector, or soap water.
X. Electrical machine control	Insulation resistance	Once/Month	Above 5MΩ is required when testing with DV500V high resistance meter	
	Wire contact	Once/Month	Insulation layer of the wire must be under good contact condition, without damage, bolt well fixed.	
	Assistant relay	Once/Month	No abnormal action	
	Time-limited relay	Once/Month	Act according to the time set	

**2). Please have the qualification of the after sale service engineer to check:**

- (1). Inspection unit control and protection setting value.
- (2). Check the electrical wiring is or not loose, if loose to timely fastening
- (3). Check the reliability of electrical components, should be promptly replaced unreliable or failure parts
- (4). check compressor oil system.
- (5). check pump and water system.

**3) Replacing dry filter**

Before replacing dry filter core filter, directly close the angle valves at both ends to discharge the residual refrigerant in the dry filter. After the replacement, fix the end cover tight, extract vacuum, and then add 2~3kg refrigerant.

If only to clean the dry filter, but not to replace it, before removal of the filter, ensure that the refrigerant in the dry filter is completely discharged and the dry filter has remained not in use for a time (to ensure the temperature of the dry filter core is close to the ambient temperature) so that the removed dry filter core with low temperature would not cause the moisture in the air to immediately reach to the dew point to condense and absorb water. Protective measures shall be taken to the removed filter to prevent it from directly contacting with the air.



If the dry filter core is dirt or has absorbed too much moisture, it must be replaced with a dry one. During the operation, inspect whether the dry filter is blocked and whether the temperatures at the dry filter inlet and outlet are close in normal conditions. If there is obvious temperature difference (above 5 °C) between the front and end of the filter, or even that frost exists at the end of the filter, it is likely to block the dry filter.



Seriously blocked dry filter must be cleaned or replaced.



If frost exists at the end, the dry filter is seriously blocked.

If the temperature difference between dry filter front and end exceeds 5°C, the dry filter is likely blocked.

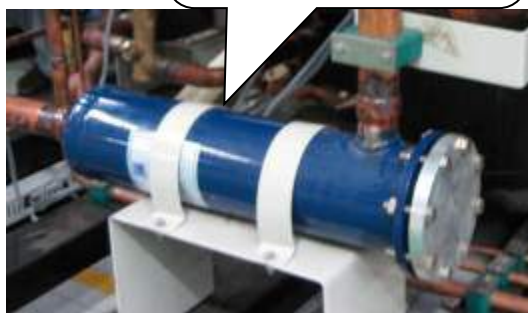

## VIII. Troubleshooting

### 1. List of failures

Failure display	Name of failure	Source of failure	Control logic
Flow switch failure	Flow switch failure	Flow switch	The flow switch will be detected in 3 minutes of pump running. If the flow switch of unit module is off all the time for 5S successively, it shall be reported for flow switch protection. Execute this failure unit in the failure stop procedure; save the content of failure. Confirm this failure manually on touch screen as required after resetting the flow switch (detection will not be carried out in the period of stop, nor started until the pump runs for 3 minutes)
Freeze protection	Freeze alarm	Antifreeze Switch	When leaving water temperature in a unit modular unit is less than or equal to 3°C and the mechanical antifreeze switch is switched off, report freeze protection, immediately stop this unit in the failure stop procedure, and save the content of failure. Save the content of failure. Do not switch on the unit modular unit (to be detected during both stop and running) in accordance with the conditions of temperature and time until this failure is confirmed manually on touch screen as required after failure is eliminated.
High-pressure alarm	High-pressure alarm	High-pressure switch	To be detected during both stop and running. Switch off the high-pressure switch when discharge pressure of the system is higher than 20Bar, report high-pressure protection, stop the module immediately in the failure stop procedure, and save the content of failure. Reset will not be allowed until system pressure is lower than the setting value after protection occurs. Do not switch on the units in accordance with the conditions of temperature and time until this failure is confirmed manually on touch screen as required after failure is eliminated.
Low-pressure alarm	Low-pressure alarm	Low-pressure switch	To be detected during both stop and running. Switch off the low-pressure switch when discharge pressure of the system is lower than 1Bar, report low-pressure protection, stop the module immediately in the failure stop procedure, and save the content of failure.
Compressor or internal protection	Compressor or internal protection	Motor protector	To be detected during both stop and running. Switch off the protection switch in compressor in the case of high temperature of compressor winding, or high compressor discharge temperature, or phase sequence error of compressor power, or phase lack. Stop the units immediately in the failure stop procedure and save the content of failure. Do not switch on the units in accordance with the conditions of temperature and time until this failure is confirmed manually on touch screen as required after failure is eliminated.
Oil level protection	Oil level protection	Oil level switch	To be continuously monitored prior to start, report oil level protection in case of continuous switch-off of oil level switch for 3S, and start of compressor is not allowed; to be detected in running, switch off the oil level switch in case of continuous switch-off of oil level switch of compressor for 60S during running of compressor. Then report oil level switch protection. Immediately stop the units in the failure stop procedure, and save the content of failure.
Oil differential pressure protection	Oil differential pressure protection	Oil differential pressure switch	To be detected in running, switch off the oil differential pressure switch when the difference between oil pressure and discharge pressure of compressor is higher than the setting value during running of compressor. The indicator of oil differential pressure switch in input interface will be out. Do not switch on the units in accordance with the conditions of temperature and time until this failure is confirmed manually on touch screen as required after switch resetting.
Contact failure	Contact failure	Contact	To be detected after start of master, report the contactor failure in case of incorrect pull-in of contactor. Do not switch on the units in accordance with the conditions of temperature and time until this

			failure is confirmed manually on touch screen as required after switch resetting.
Compressor overload	Compressor overload	Compressor overload relay	Report compressor overload protection when the current value of unit compressor is greater than the setting value and energy accumulated to result in thermo relay trip. Stop the module immediately in the failure stop procedure, and save the content of failure. Do not switch on the units in accordance with the conditions of temperature and time until this failure is confirmed manually on touch screen as required after failure is eliminated.
Fans overload	Fans overload	Fans overload relay	Report fans motor overload protection when the current value of unit fans is greater than the setting value and energy accumulated to result in thermo relay trip. Stop the compressors and fans (simultaneously) immediately for this module, and save the content of failure. Do not switch on the units in accordance with the conditions of temperature and time until this failure is confirmed manually on touch screen as required after switch resetting.
Power Failure	Power Failure	Phase sequence protector	To be detected at any time, report power failure in cases of high / low voltage of power or phase unbalance and phase lack. Failure will be eliminated after power gets right. Notes: phase lack / phase stagger of power will be detected during both initial stage of power-on and unit running.
High Fin temp.	High Fin temp.	Fin temp. sensor	To be detected in running, the fin temperature of the system is higher than 65°C, and the failure record indicates that the fin temperature is too high.
High Discharge temp.	High Discharge temp.	Discharge temp. sensor	To be detected in running, the discharge temperature of the system is higher than 110°C, and the failure record indicates that the discharge temperature is too high.
Leaving water temp. sensor failure	Leaving water temp. sensor failure	Leaving water temp. sensor	 <p>Switch off compressors in case of failure of the sensor itself. Switch-off of pump and fans will be delayed. The failure indicator of display board will be on, and a corresponding alarm mark will be displayed in "Failure Query". The compressors will not be restarted until the failure of sensor is eliminated, and the failure signal must be cleared manually, otherwise it cannot be cleared.</p>
Entering water temp. sensor failure	Entering water temp. sensor failure	Entering water temp. sensor	
Fin temp. sensor failure	Fin temp. sensor failure	Fin temp. sensor	
Ambient temp. sensor failure	Ambient temp. sensor failure	Ambient temp. sensor	
Discharge temp. sensor failure	Discharge temp. sensor failure	Discharge temp. sensor	
Suction temp. sensor failure	Suction temp. sensor failure	Suction temp. sensor	
Low-pressure alarm	Low-pressure alarm	Low-pressure switch	
High-pressure alarm	High-pressure alarm	High-pressure switch	Do not restart the units until confirming manually on touch screen as required when the discharge pressure detected by the system is lower than the setting value for continuously 1s.

Differential pressure alarm	Differential pressure alarm	Differential pressure switch	To be detected in running. Currently, there are two modes, one is direct use of differential pressure switch, namely that when the difference between high pressure and low pressure of the system is smaller than the setting value of 4Bar, the differential pressure switch will be switched off, and the indicator of differential pressure switch of input interface will be out. The other is PLC calculation, namely that an alarm will be given if the differential pressure is smaller than 4Bar.
Low Suction Pressure	Low Suction Pressure	Low-pressure sensor	To be detected in running, report protection of too low suction pressure when the refrigeration suction pressure is lower than 1Bar, and the units will not be restarted until it is confirmed manually on touch screen as required.
High Discharge Pressure	High Discharge Pressure	High-pressure sensor	To be detected in running, report protection of high discharge pressure when the discharge pressure is higher than 20Bar, and the units will not be restarted until it is confirmed manually on touch screen as required.
Beyond the operation range	Beyond the operation range	Ambient temp. sensor, entering water temp. sensor	The system will be automatically stopped when the ambient temperature detected by the system exceeds that set by the system for continuously 5 minutes.
Mode water temp. protection	Mode water temp. protection	Entering / Leaving water temp. sensor	Detect water temperature in the refrigeration mode after start for 5 minutes, and report mode water temp. protection when leaving water temperature is not lower than entering water temperature for continuously 5s.
EXV module failure	EXV module failure	EXV Control Module	Start detection upon power-on of units, and report immediately failure of EXV module when the alarm output point of EXV control module is switched off.



## 2. Common troubleshooting

### 1) High voltage protection

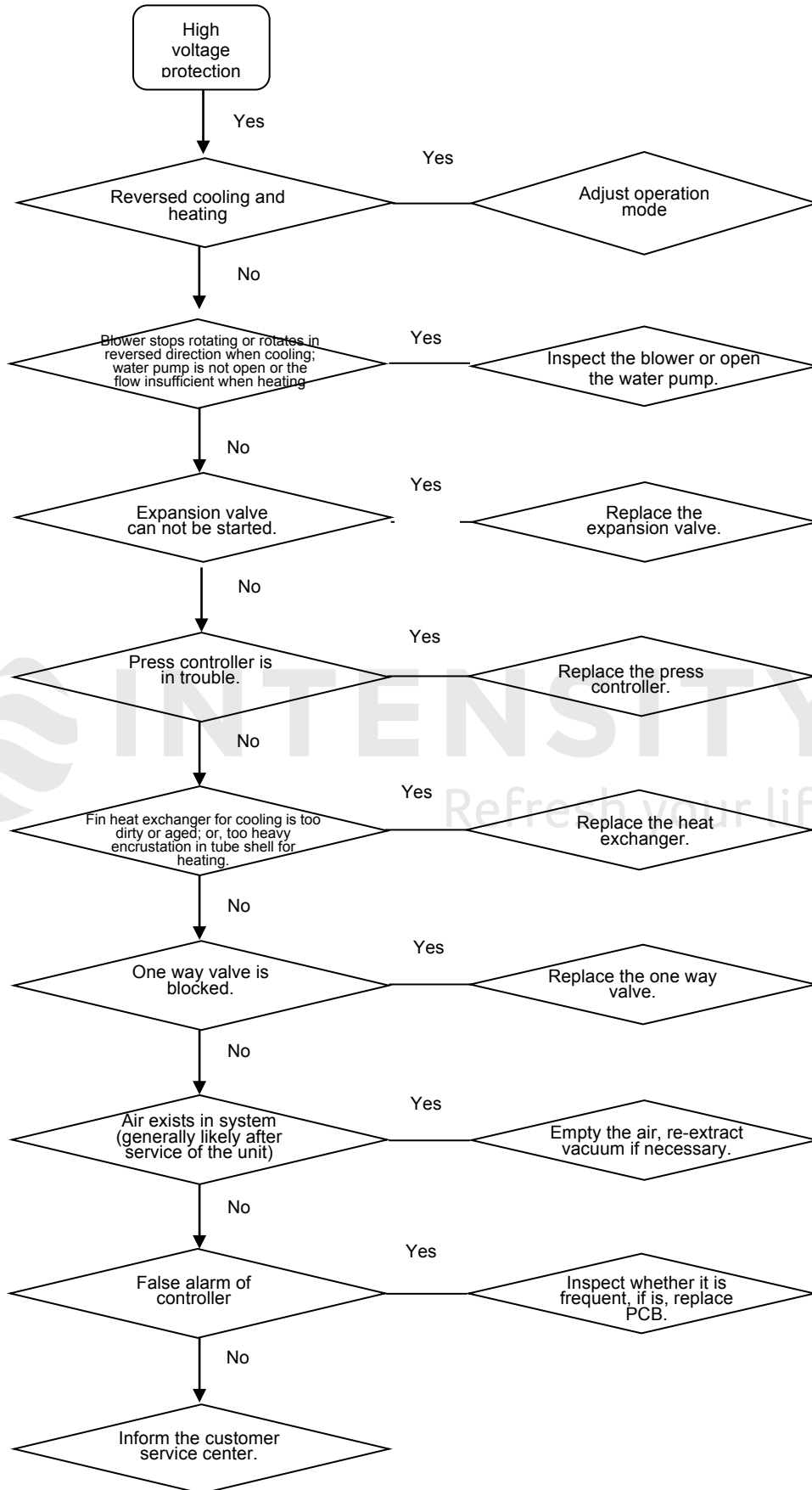

## 2) Low voltage protection

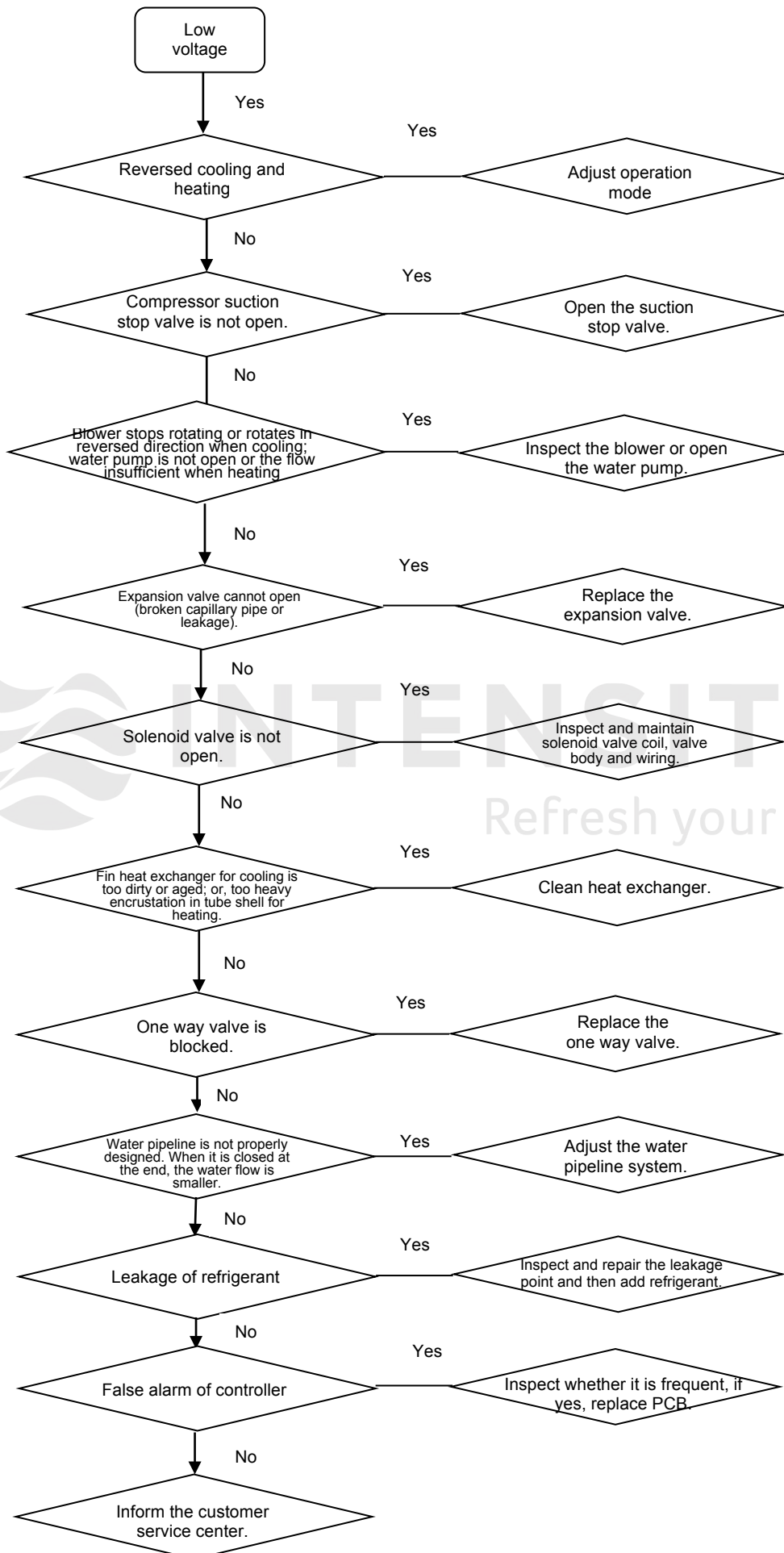

### 3) Overheat discharge temperature protection

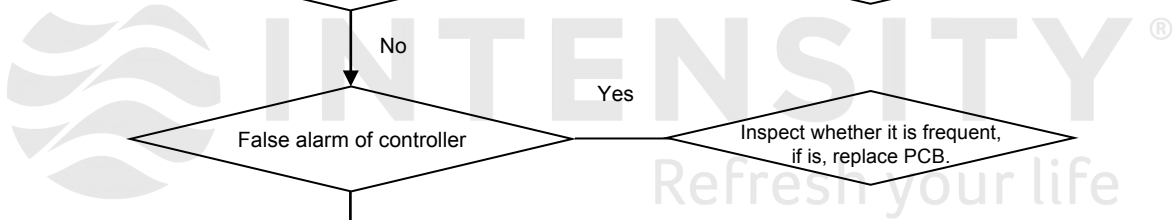
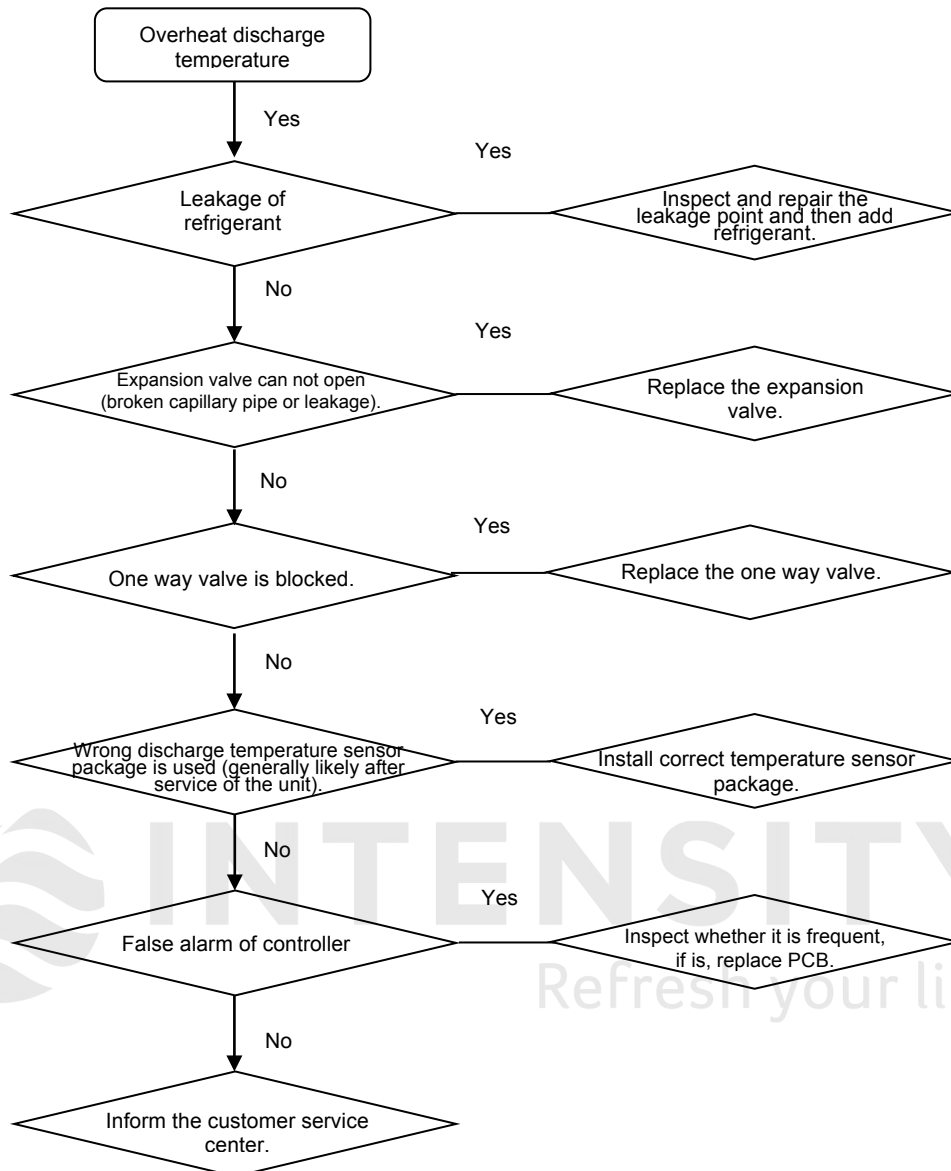

4) Compressor overload protection

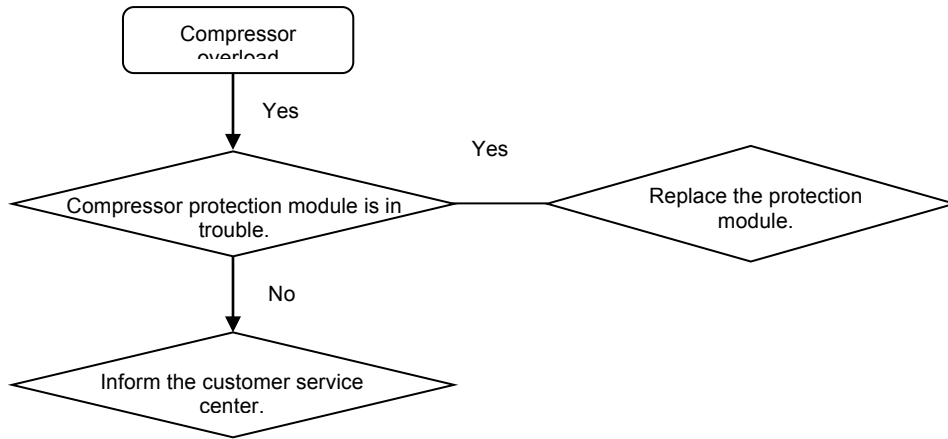

5) Differential pressure alarm

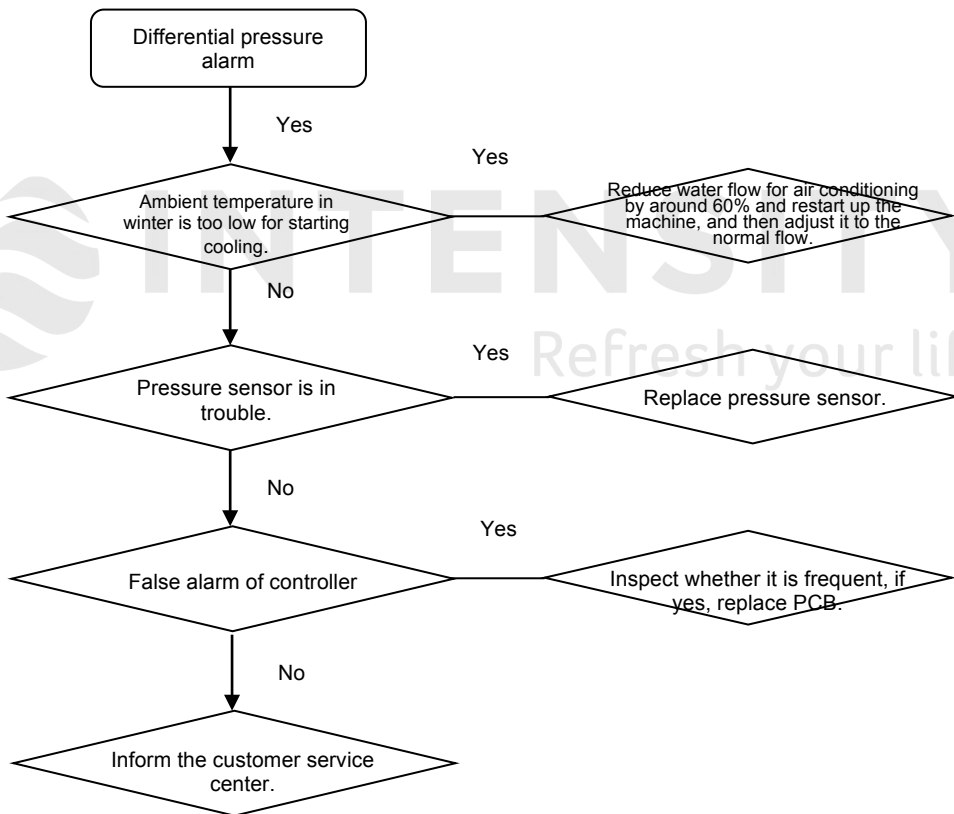

6) Flow switch failure

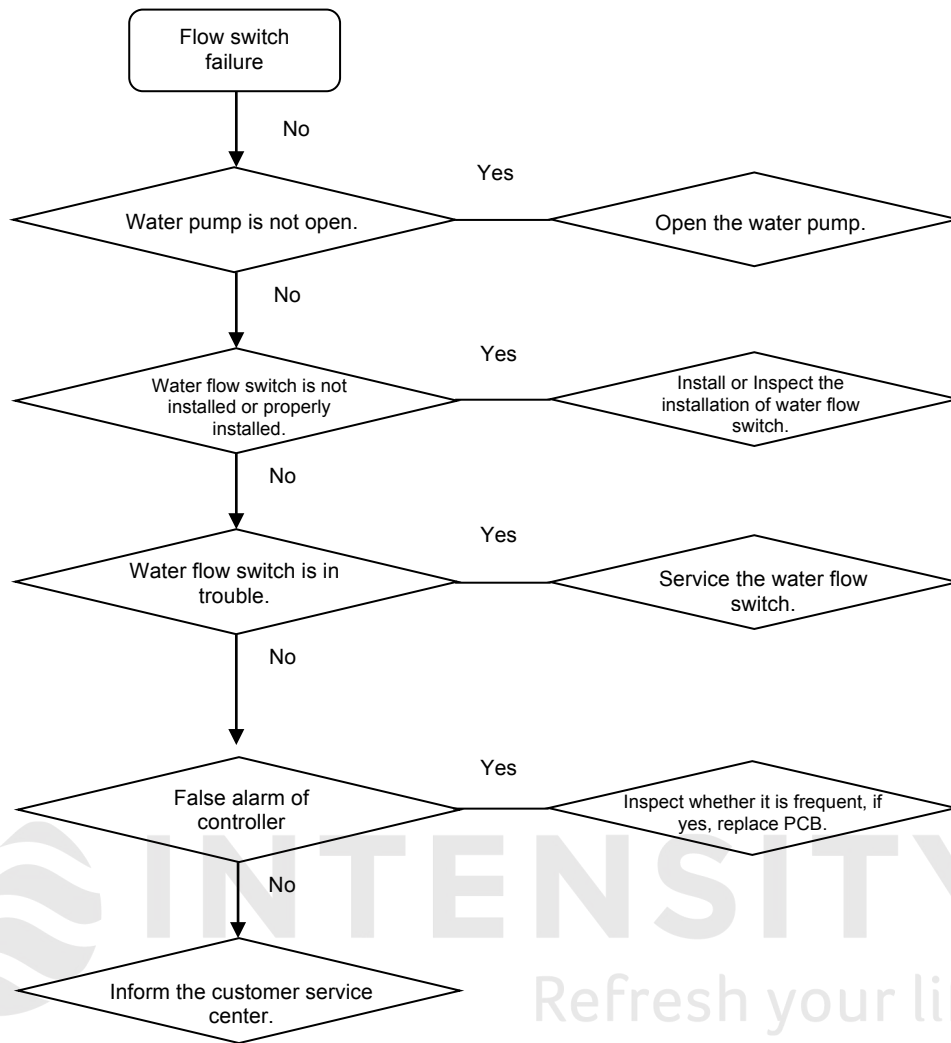

## 7) Power failure

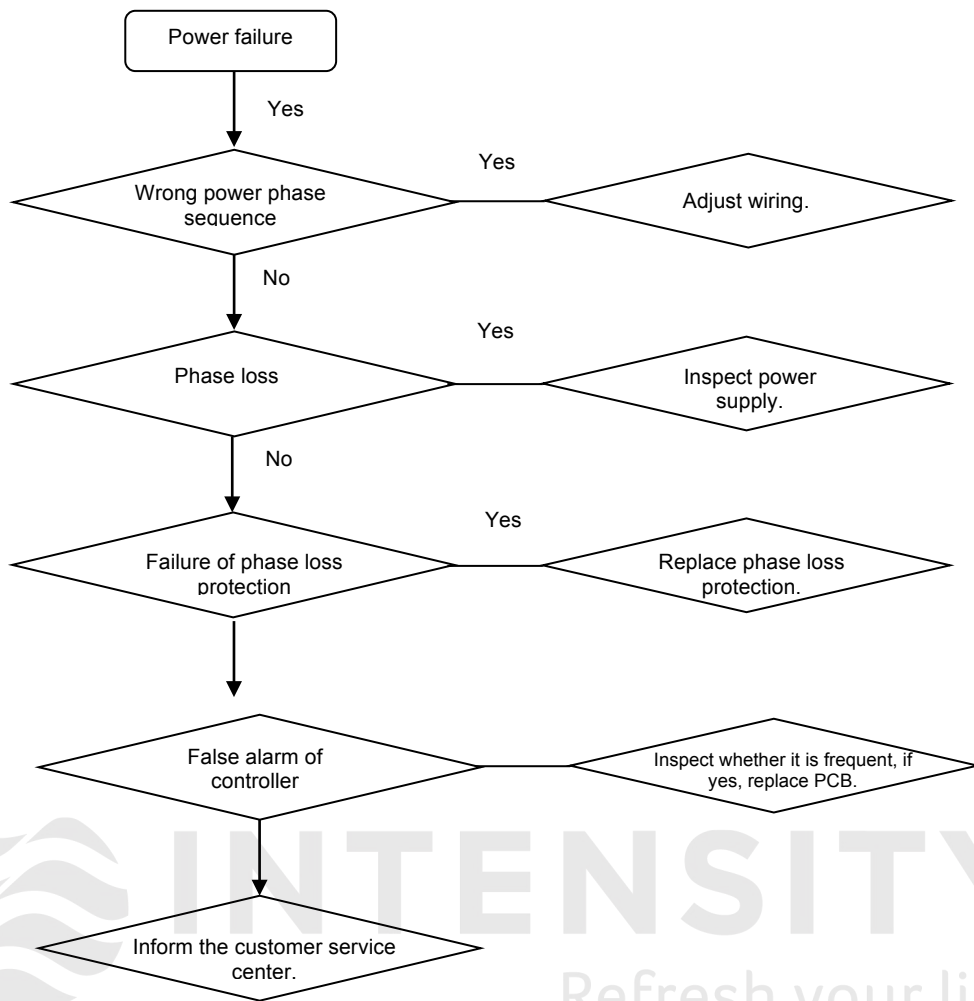

## IX. Appendix 1

### 1. Temperature-Resistance characteristic sheet for discharge temperature sensor

NTC sensor characteristic sheet

Unit : Temp:°C --K.Ratio:KΩ, 5K@90°C

Temp.	Ratio	Temp.	Ratio	Temp.	Ratio	Temp.	Ratio
-20	542.7	20	68.66	60	13.59	100	3.702
-19	511.9	21	65.62	61	13.11	101	3.595
-18	483	22	62.73	62	12.65	102	3.492
-17	455.9	23	59.98	63	12.21	103	3.392
-16	430.5	24	57.37	64	11.79	104	3.296
-15	406.7	25	54.89	65	11.38	105	3.203
-14	384.3	26	52.53	66	10.99	106	3.113
-13	363.3	27	50.28	67	10.61	107	3.025
-12	343.6	28	48.14	68	10.25	108	2.941
-11	325.1	29	46.11	69	9.902	109	2.86
-10	307.7	30	44.17	70	9.569	110	2.781
-9	291.3	31	42.33	71	9.248	111	2.704
-8	275.9	32	40.57	72	8.94	112	2.63
-7	261.4	33	38.89	73	8.643	113	2.559
-6	247.8	34	37.3	74	8.358	114	2.489
-5	234.9	35	35.78	75	8.084	115	2.422
-4	222.8	36	34.32	76	7.82	116	2.357
-3	211.4	37	32.94	77	7.566	117	2.294
-2	200.7	38	31.62	78	7.321	118	2.233
-1	190.5	39	30.36	79	7.086	119	2.174
0	180.9	40	29.15	80	6.859	120	2.117
1	171.9	41	28	81	6.641	121	2.061
2	163.3	42	26.9	82	6.43	122	2.007
3	155.2	43	25.86	83	6.228	123	1.955
4	147.6	44	24.85	84	6.033	124	1.905
5	140.4	45	23.89	85	5.844	125	1.856
6	133.5	46	22.89	86	5.663	126	1.808
7	127.1	47	22.1	87	5.488	127	1.762
8	121	48	21.26	88	5.32	128	1.717
9	115.2	49	20.46	89	5.157	129	1.674
10	109.8	50	19.69	90	5	130	1.632
11	104.6	51	18.96	91	4.849		
12	99.69	52	18.26	92	4.703		
13	95.05	53	17.58	93	4.562		
14	90.66	54	16.94	94	4.426		
15	86.49	55	16.32	95	4.294		
16	82.54	56	15.73	96	4.167		
17	78.79	57	15.16	97	4.045		
18	75.24	58	14.62	98	3.927		
19	71.86	59	14.09	99	3.812		

2. Temperature-Resistance characteristic sheet for water temp. sensor, ambient temp. sensor, oil temp. sensor.

NTC sensor characteristic sheet

Unit: Temp:°C--K . Ratio:KΩ, 10K@25°C

Temp	Ratio	Temp	Ratio	Temp	Ratio	Temp.	Ratio
-20	103.882	20	12.598	60	2.383	100	0.623
-19	97.868	21	12.023	61	2.296	101	0.605
-18	92.246	22	11.478	62	2.213	102	0.587
-17	86.987	23	10.961	63	2.134	103	0.570
-16	82.065	24	10.470	64	2.057	104	0.553
-15	77.457	25	10.005	65	1.984	105	0.537
-14	73.106	26	9.564	66	1.913	106	0.521
-13	69.031	27	9.146	67	1.846	107	0.506
-12	65.211	28	8.749	68	1.781	108	0.492
-11	61.629	29	8.372	69	1.718	109	0.478
-10	58.270	30	8.013	70	1.659	110	0.464
-9	55.099	31	7.669	71	1.601		
-8	52.123	32	7.342	72	1.546		
-7	49.328	33	7.031	73	1.492		
-6	46.703	34	6.735	74	1.441		
-5	44.235	35	6.453	75	1.392		
-4	41.896	36	6.183	76	1.346		
-3	39.697	37	5.927	77	1.301		
-2	37.628	38	5.683	78	1.258		
-1	35.682	39	5.450	79	1.217		
0	33.849	40	5.228	80	1.177		
1	32.115	41	5.016	81	1.139		
2	30.483	42	4.813	82	1.101		
3	28.944	43	4.620	83	1.066		
4	27.494	44	4.436	84	1.031		
5	26.126	45	4.261	85	0.998		
6	24.833	46	4.092	86	0.966		
7	23.613	47	3.932	87	0.935		
8	22.461	48	3.778	88	0.906		
9	21.373	49	3.632	89	0.877		
10	20.344	50	3.492	90	0.850		
11	19.365	51	3.357	91	0.823		
12	18.438	52	3.229	92	0.798		
13	17.563	53	3.106	93	0.773		
14	16.734	54	2.989	94	0.749		
15	15.950	55	2.876	95	0.727		
16	15.205	56	2.769	96	0.704		
17	14.500	57	2.666	97	0.683		
18	13.831	58	2.568	98	0.662		
19	13.198	59	2.473	99	0.643		



3. Temperature-Resistance characteristic sheet for EXV temp. sensor.

NTC Sensor characteristic sheet

Unit: Temp:°C--K. Ratio:KΩ10K@25°C

Temp.	Ratio	Temp.	Ratio	Temp.	Ratio	Temp.	Ratio
-20	67.74	20	12.09	60	3.02	100	0.97
-19	64.54	21	11.63	61	2.92	101	0.94
-18	61.52	22	11.20	62	2.83	102	0.92
-17	58.66	23	10.78	63	2.75	103	0.90
-16	55.95	24	10.38	64	2.66	104	0.87
-15	53.39	25	10.00	65	2.58	105	0.85
-14	50.96	26	9.63	66	2.51	106	0.83
-13	48.65	27	9.28	67	2.43	107	0.81
-12	46.48	28	8.94	68	2.36	108	0.79
-11	44.41	29	8.62	69	2.29	109	0.77
-10	42.25	30	8.31	70	2.22	110	0.75
-9	40.56	31	8.01	71	2.16		
-8	38.76	32	7.72	72	2.10		
-7	37.05	33	7.45	73	2.04		
-6	35.43	34	7.19	74	1.98		
-5	33.89	35	6.94	75	1.92		
-4	32.43	36	6.69	76	1.87		
-3	31.04	37	6.46	77	1.81		
-2	29.72	38	6.24	78	1.76		
-1	28.47	39	6.03	79	1.71		
0	27.28	40	5.82	80	1.66		
1	67.74	41	5.63	81	1.62		
2	26.13	42	5.43	82	1.57		
3	25.03	43	5.25	83	1.53		
4	23.99	44	5.08	84	1.49		
5	22.99	45	4.91	85	1.45		
6	22.05	46	4.74	86	1.41		
7	21.15	47	4.59	87	1.37		
8	20.29	48	4.44	88	1.33		
9	19.40	49	4.30	89	1.30		
10	18.70	50	4.16	90	1.26		
11	17.96	51	4.02	91	1.23		
12	17.24	52	3.90	92	1.20		
13	16.55	53	3.77	93	1.16		
14	15.90	54	3.65	94	1.13		
15	15.28	55	3.53	95	1.10		
16	14.68	56	3.42	96	1.08		
17	14.12	57	3.31	97	1.05		
18	13.57	58	3.21	98	1.02		
19	13.06	59	3.11	99	0.99		

**Temperature-Resistance characteristic sheet for EXV temp. sensor.**

**NTC Sensor characteristic sheet**

Unit: Temp:°C--K. Ratio:KΩ 50K@25°C

Temp	Ratio	Temp.	Ratio	Temp.	Ratio	Temp.	Ratio
-40	1630,77						
-35	1178,11						
-30	860,97						
-25	636,08						
-20	474,78						
-15	357,83						
-10	272,18						
-5	208,83						
0	161,56						
5	125,97						
10	98,96						
15	78,29						
20	62,37						
25	50,00						
30	40,34						
35	32,73						
40	26,71						
45	21,92						
50	18,08						
55	14,99						
60	12,48						
65	10,44						
70	8,78						
75	7,41						
80	6,28						
85	5,34						
90	4,56						
95	3,91						
100	3,37						
105	2,91						
110	2,52						
115	2,19						
120	1,91						
125	1,67						
130	1,46						
135	1,28						
140	1,13						
145	1,00						
150	0,89						

